

Test Report

Document No.	00782-21-0416	Copy No.	1	Number of pages	42
Apparatus	Fuse-switch-disconnector				
Designation	TES-00/800 TES-1/800				
Serial Number	Test samples				
Manufacturer	THS Componentes Elétricos Ltda Rua Irineu Dias da Rosa, 25 Chac 3 Marias - Sorocaba - SP CEP: 18105-310 - BRAZIL				
Client	THS Componentes Elétricos Ltda Rua Irineu Dias da Rosa, 25 Chac 3 Marias - Sorocaba - SP CEP: 18105-310 - BRAZIL				
Date(s) of test(s)	06 to 11 August 2021				
Tested by	IPH Institut „Prüffeld für elektrische Hochleistungstechnik“ GmbH Landsberger Allee 378A 12681 Berlin GERMANY				
Test(s) performed	Test sequence I: General performance characteristics				

The apparatus, constructed in accordance with the description, drawings and photographs incorporated in this document has been subjected to the series of proving tests in accordance with:
IEC 60947-3: 2020-04

The results are documented in this test report. The ratings assigned by the Manufacturer are listed on the ratings page. The document applies only to the apparatus tested. The responsibility for conformity of any apparatus having the same designations with that tested rests with the Manufacturer.

02 September 2021

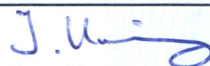
Jens Haring
Test Engineer in charge

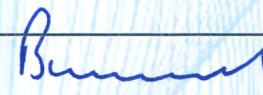
Ronald Borchert
Approved by

Date

Partial reproduction of this document is permitted only with the written permissions from CESI Group. The authenticity of this document is guaranteed by the integrity of hologram.



Deutsche
Akkreditierungsstelle
D-PL-12107-01-00

IPH Institut "Prüffeld für elektrische Hochleistungstechnik" GmbH is accredited testing laboratory by DAkkS according to EN ISO/IEC 17025:2018. The accreditation is valid only for the scope listed in the annex of the accreditation certificate D-PL-12107-01-00. www.dakks.de

测思
CENTRO
ELETTROTECNICO
SPERIMENTALE
ITALIANO



CESI

Trust the Power of Experience

Notes

STL-Member

CESI Group members are founder members of the SHORT-CIRCUIT TESTING LIAISON (STL) which has been established in 1969. STL is a forum for voluntary international cooperation of testing organizations.

CESI Group Test Documents description

Type Test Certificate of

Issued for type tests of high voltage products ($> 1 \text{ kV}_{ac}$; $> 1,5 \text{ kV}_{dc}$), which have successfully been carried out in full compliance with the relevant specifications or standards and STL Guides valid at the time of the test. The Type Test Certificate consists of documents unequivocally identifying the test object and describes all conditions under which the tests were conducted. It gives evidence of the unobjectionable behavior of the test object during the tests in line with the normative documents applied as well as of the results of successful testing.

Test Certificate of (complete / selected) Type Tests

Issued if type tests of low voltage products ($< 1 \text{ kV}_{ac}$; $< 1,5 \text{ kV}_{dc}$) requested by the relevant product standard were passed. For these tests the equipment under test must be clearly identified by technical description, drawings, and additional specifications.

Certificate of Design Verification

Issued for passed design verification tests according to IEC 61439. For these tests the equipment under test must be clearly identified by technical description, drawings, and additional specifications.

Type Test Report

Issued for high and low voltage products if parts of selected type tests have been passed; those shall be carried out in full compliance with the relevant standards but (for high voltage products) do not fulfill all STL requirements for issuing a Type Test Certificate. For these tests the equipment under test must be clearly identified by technical description, drawings, and additional specifications.

Test Report

Issued for all other tests on high and low voltage products which have been carried out according to specifications, standards and/or client instructions

On-Site Test Record

Issued as a record of results acquired during the on-site tests / measurements

Test Award

Can be additionally issued for all named types of test documents above if the tests to be referenced were passed

Ratings and characteristics assigned by the manufacturer and proven by test

Description		Rating	Verified
Rated operational voltage	U_e	800 V	
Rated insulation voltage	U_i	1000 V	X
Rated impulse withstand voltage	U_{imp}	8 kV	X
Rated operational current	I_e		
TES-00/800		160 A	X
TES-1/800		250 A	X
Conventional free air thermal current	I_{th}		
TES-00/800		160 A	X
TES-1/800		250 A	X
Rated frequency		50 Hz	
Utilization category		AC-21B	X
Degree of pollution		3	
Material group		IIIa	
Overvoltage category		IV	

The ratings of the test object marked with **X** and related to the scope of test(s) performed have been proved.

Contents	Sheet
1. Present at the test.....	5
2. Test performed.....	5
3. Identity of the test object.....	6
3.1 Technical data and characteristics.....	6
3.2 Identity documents.....	6
4. Test sequence I: General performance characteristics.....	7
4.1 Temperature-rise.....	7
4.2 Dielectric properties.....	11
4.3 Making and breaking capacities.....	14
4.4 Dielectric verification.....	18
4.5 Leakage current.....	19
4.6 Temperature-rise verification.....	20
4.7 Strength of actuator mechanism.....	23
5. Photos.....	24
6. Oscillograms.....	30
7. Drawings.....	40

Distribution

Copy No. 1

Copy No. 1 in English:

THS Componentes Eléctricos Ltda

TEST REPORT NO. 00782-21-0416

1. Present at the test

Mr. Jens Haring IPH test engineer in charge

2. Test performed

Test sequence I: General performance characteristics

- Temperature-rise
- Dielectric properties
- Making and breaking capacities
- Dielectric verification
- Leakage current
- Temperature-rise verification
- Strength of actuator mechanism

3. Identity of the test object

3.1 Technical data and characteristics

The technical data and characteristics of the test object are defined by the following parameters and specified by the client

Test object:	Fuse-switch-disconnector		
Type:	TES-00/800 TES-1/800		
Manufacturer:	THS Componentes Elétricos Ltda		
Serial No.:	Test samples		
Year of manufacture:	2021		
Characteristics:	Number of poles	3 in horizontal design	
	Kind of current	3 AC, 50 Hz	
	Breaking arrangement	Double opening	
	Suitable for isolation	Yes	
	Manual operation	Dependent	
	Dimension H x W x D		
	TES-00/800	172 mm x 106 mm x 88 mm	
	TES-1/800	294 mm x 210 mm x 138 mm	
	Terminal torque		
	TES-00/800	15 Nm	
	TES-1/800	25 Nm	
Material:	Material of base	Polyamide 6.6, 20% glass fiber reinforced, flame retardant rated V0 acc. to UL-94	
	Material of cover	Polyamide 6.6, flame retardant rated V0 acc. to UL-94	
	Material of actuator	Polyamide 6.6, 20% glass fiber reinforced, flame retardant rated V0 acc. to UL-94	
	Material of terminals/contacts	Silver plated copper C11000	
	Material of compression spring	Hard drawn carbon steel	

3.2 Identity documents

The manufacturer confirms that the test object has been manufactured in compliance with the drawings given in this document. IPH did not verify this compliance in detail.

The identity of the test object is fixed by the following drawings and data submitted by the client:

Name of drawing	Drawing No.	Date of drawing	Author	Notes
Chave NH00/000	--	16/08/21	THS	Sheet 40
Chave NH1	--	16/08/21	THS	Sheet 41
SECCIONADORA NH TES 800V - SOB CARGA	--	--	THS	Sheet 42

Entry of test object at IPH: 03 August 2021

4. Test sequence I: General performance characteristics

4.1 Temperature-rise

4.1.1 Test laboratory

Low-voltage test laboratory, test rooms 4 and 7

4.1.2 Normative document

IEC 60947-3: 2020-04, Sub-clause 9.3.4.2

4.1.3 Required test parameters

Test current TES-00/800:	160 A, three-phase
Test current TES-1/800:	250 A, three-phase
Test frequency:	50 Hz

4.1.4 Test arrangement

The test object was mounted, as specified by the manufacturer, in normal position of use.

All terminals were connected by 4-m flexible copper cables with a cross-section of 70 mm² for TES-00/800 and 120 mm² for TES-1/800.

The torque of the terminal screws was 15 Nm for TES-00/800 and 25 Nm for TES-1/800.

4.1.5 Test and measuring circuits

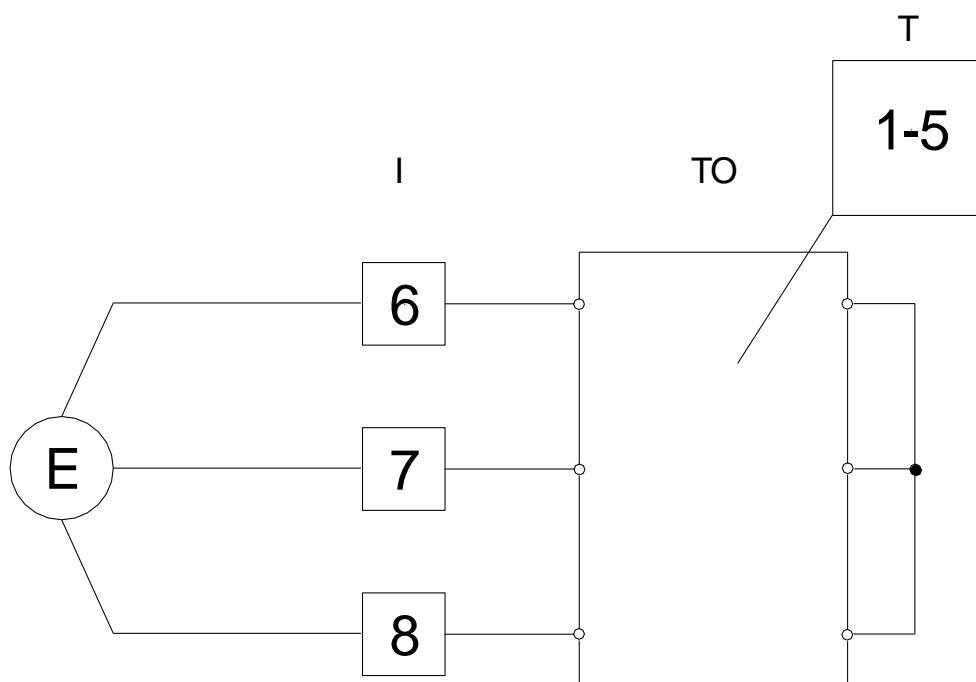

- E Power supply
- I Current measurement
- T Temperature measurement
- TO Test object

Figure 1: Test circuit for the temperature-rise test

Technical data of measuring circuits

Measuring point	Measured quantity	Measuring sensor
1 - 5	Temperature	Cu/constantan thermocouples
6	Test current L1	Rogowski coil, integrator
7	Test current L2	Rogowski coil, integrator
8	Test current L3	Rogowski coil, integrator
Measuring instruments:		
Measuring points 1 - 5:	ALMEMO® 5690-2 XU	
Measuring points 6 - 8:	Digital Display SPE	

4.1.6 Test results

4.1.6.1 TES-00/800

The temperature-rise test was carried out with THS NH00 fuse links (800V, 160A, gL/gG, 50kA, 12W).

Date of test: 10 August 2021
 Test current: 161 A / 160 A / 160 A
 Test frequency: 50 Hz

Condition of test object: New
 Ambient air: 25.7 °C

Meas. point/ Phase	Designation	Classification	Material	Final temperature measured [°C]	Final temperature rise [K]	Temperature-rise limit permitted [K]	
1	L1	Upper terminals	Terminal	Copper, silver-coated	83.3	57.6	70
	L2				92.8	67.1	
	L3				76.3	50.6	
2	L1	Lower terminals	Terminal	Copper, silver-coated	79.1	53.4	70
	L2				79.4	53.7	
	L3				72.3	46.6	
3	-	Manual operating means	Manual actuator	Insulating material	36.7	11.0	25
4	-	Enclosure on the front side, intended to be touched but not hand hold	Exposed part	Insulating material	62.5	36.8	40
5	-	Enclosure, not touched during normal operation	Exposed part	Insulating material	73.5	47.8	50

The final temperature-rise values measured did not exceed the temperature-rise limits defined by IEC 60947-3, Sub-clause 8.2.2.

4.1.6.2 TES-1/800

The temperature-rise test was carried out with THS NH1 fuse links (800V, 250A, gL/gG, 50kA, 23W).

Date of test: 10 August 2021
 Test current: 253 A / 251 A / 251 A
 Test frequency: 50 Hz

Condition of test object: New
 Ambient air: 26.5 °C

Meas. point/ Phase	Designation	Classification	Material	Final temperature measured [°C]	Final temperature rise [K]	Temperature-rise limit permitted [K]	
1	L1	Upper terminals	Terminal	Copper, silver-coated	70.3	43.8	70
	L2				93.8	67.3	
	L3				71.8	45.3	
2	L1	Lower terminals	Terminal	Copper, silver-coated	58.5	32.0	70
	L2				73.7	47.2	
	L3				63.2	36.7	
3	-	Manual operating means	Manual actuator	Insulating material	31.4	4.9	25
4	-	Enclosure on the front side, intended to be touched but not hand hold	Exposed part	Insulating material	51.7	25.2	40
5	-	Enclosure, not touched during normal operation	Exposed part	Insulating material	46.2	19.7	50

The final temperature-rise values measured did not exceed the temperature-rise limits defined by IEC 60947-3, Sub-clause 8.2.2.

4.2 Dielectric properties

4.2.1 Test laboratory

Low-voltage test laboratory, test room 4

4.2.2 Normative document

IEC 60947-3: 2020-04, Sub-clause 9.3.4.3

4.2.3 Required test parameters

- Verification of impulse withstand voltage

Lightning impulse voltage 1.2/50 μ s:	12.3 kV	Insulation of isolating distances
Lightning impulse voltage 1.2/50 μ s:	9.8 kV	Phase-to-phase insulation and phase-to-earth insulation
No. of tests:	5 each	
Polarity:	Positive and negative to earth	

- Power-frequency withstand verification of solid insulation

50 Hz AC test voltage:	2200 V
Duration of test:	60 s each

- Verification of creepage distances

Minimum creepage distance:	16 mm	(Degree of pollution 3)
----------------------------	-------	-------------------------

- Leakage current

Test voltage:	880 V (1.1 x U_n)
Test frequency:	50 Hz

4.2.4 Test arrangement

Actuators of insulating material and non-metallic enclosure intended to be touched were covered by a metal foil.

4.2.5 Test results

4.2.5.1 TES-00/800

- **Verification of impulse withstand voltage and of power-frequency withstand of solid insulation**

Date of test: 11 August 2021

Atmospheric conditions during test

Air temperature: 24.1 °C
 Air pressure: 1013 mbar
 Air humidity: 51 %

Voltage applied to	Earthed	Position of operation	Applied test voltage 1.2/50 μ s kV	Results Number of tests/ disruptive discharges	Applied test voltage 50 Hz, 60 s V	Results Disruptive discharges
All terminals of the main circuit connected together	Enclosure / mounting plate	Close	\pm 9.8	5 each/0	2200	0
		Open	\pm 9.8	5 each/0	2200	0
Each pole of the main circuit	Other poles connected together and to enclosure	Close	\pm 9.8	5 each/0	2200	0
		Open	\pm 9.8	5 each/0	2200	0
Line terminals connected together	Load terminals connected together	Open	\pm 12.3	5 each/0	2200	0

- **Verification of creepage distances**

The minimum creepage distance measured to Annex G is 27 mm. The required minimum creepage distance limit has been observed.

- **Leakage current**

The leakage current of max. 8.8 μ A measured, was less than the permissible value of 2 mA.

4.2.5.2 TES-1/800

- **Verification of impulse withstand voltage and of power-frequency withstand of solid insulation**

Date of test: 11 August 2021

Atmospheric conditions during test

Air temperature: 24.1 °C
 Air pressure: 1013 mbar
 Air humidity: 51 %

Voltage applied to	Earthed	Position of operation	Applied test voltage 1.2/50 μ s kV	Results Number of tests/ disruptive discharges	Applied test voltage 50 Hz, 60 s V	Results Disruptive discharges
All terminals of the main circuit connected together	Enclosure / mounting plate	Close	± 9.8	5 each/0	2200	0
		Open	± 9.8	5 each/0	2200	0
Each pole of the main circuit	Other poles connected together and to enclosure	Close	± 9.8	5 each/0	2200	0
		Open	± 9.8	5 each/0	2200	0
Line terminals connected together	Load terminals connected together	Open	± 12.3	5 each/0	2200	0

- **Verification of creepage distances**

The minimum creepage distance measured to Annex G is 54 mm. The required minimum creepage distance limit has been observed.

- **Leakage current**

The leakage current of max. 4.0 μ A measured, was less than the permissible value of 2 mA.

4.3 Making and breaking capacities

4.3.1 Test laboratory

Low-voltage test laboratory, test room 4

4.3.2 Normative document

IEC 60947-3: 2020-04, Sub-clause 9.3.4.4

4.3.3 Required test parameters

	TES-00/800 AC-21B	TES-1/800 AC-21B
Test voltage:	840 V (1.05 x U _e)	840 V (1.05 x U _e)
Test current (making):	240 A (1.5 x I _e)	375 A (1.5 x I _e)
Test current (breaking):	240 A (1.5 x I _e)	375 A (1.5 x I _e)
Power factor:	0.95	0.95
Test frequency:	50 Hz	50 Hz
Number of operating cycles:	5	5

4.3.4 Test arrangement

The test object was mounted, as specified by the manufacturer, in normal position of use. The terminals were connected with 4-m long, insulated single-core copper cables with a cross-section of 70 mm² per pole for TES-00/800 and with 120 mm² for TES-1/800.

The torque of the screws at the terminals was 15 Nm for TES-00/800 and 25 Nm for TES-1/800.

4.3.5 Test and measuring circuits

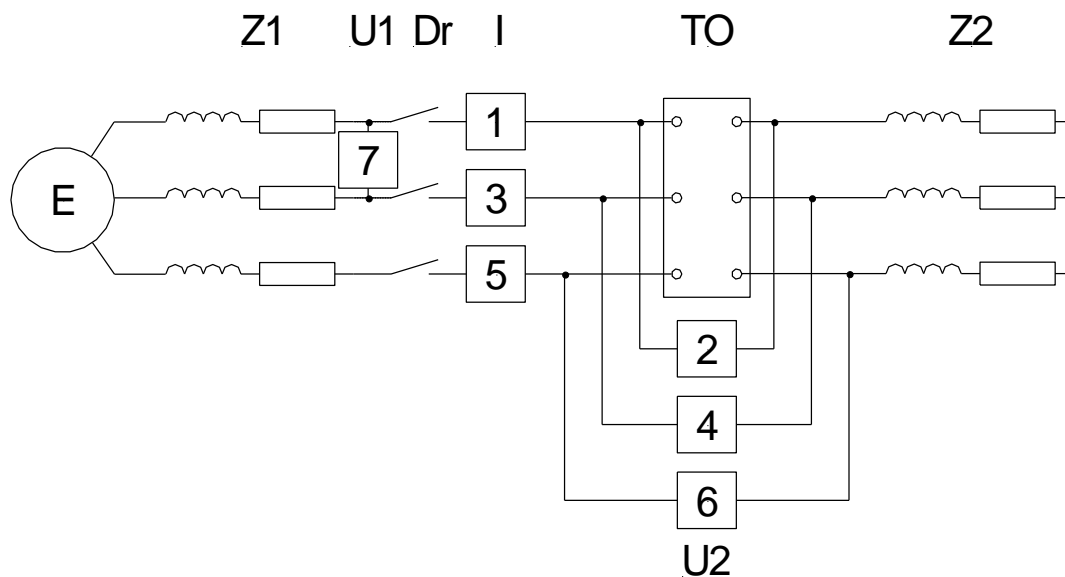

E	Power supply	U1	Test voltage measurement
Dr	Making switch	U2	Transient voltage measurement
Z1, Z2	Test circuit impedances	I	Current measurement
TO	Test object	1 - 7	Measuring points

Figure 2: Circuit for the test of making and breaking capacities

Technical data of measuring circuits

Measuring point	Measured quantity	Measuring sensor
1	Current L1	Shunt
3	Current L2	Shunt
5	Current L3	Shunt
2	Voltage across pole L1	RC divider
4	Voltage across pole L2	RC divider
6	Voltage across pole L3	RC divider
7	Test voltage	Voltage transformer

Measuring instruments:
 Measuring points 1 - 6: BAKKER transient recorder with BE 256 A/D transducers
 Measuring point 7: Digital voltmeter

4.3.6 Test results

4.3.6.1 TES-00/800

Date of test: 06 August 2021
 Test requirement: Test of making and breaking capacities AC-21B
 Operating cycle: 5 x CO-t (t - dead time)
 Connection of test object: - Power supply at the upper terminals
 - Load circuit at the lower terminals
 Distance of metallic screen from test object: Top: 50 mm, sides: 20 mm
 Condition of test object before test: New

Test parameters:

Test No.		4213959	4213960	4213961	4213962	4213963
Operating cycle		1. CO-t	2. CO-t	3. CO-t	4. CO-t	5. CO
Dead time	s	30	30	30	30	-
Applied voltage	V	850	850	850	850	850
Prospective peak current	A	L1	347	347	347	347
		L2	345	345	345	345
		L3	349	349	349	349
Prospective test current r.m.s.	A	L1	245	245	245	245
		L2	241	241	241	241
		L3	247	247	247	247
	Average	244	244	244	244	244
Power factor cos φ		0.94	0.94	0.94	0.94	0.94
Breaking current	A	L1	246	245	245	244
		L2	244	244	243	243
		L3	248	247	247	247
Recovery voltage	V	L1	490	492	491	492
		L2	506	505	504	504
		L3	490	491	490	491
	Average phase-to-phase	858	859	857	859	
Joule integral	10 ³ A ² s	L1	13.7	14.3	14.3	14.2
		L2	13.6	14.0	13.9	13.9
		L3	13.7	14.6	14.5	14.4
Duration of current flow	ms	226	236	237	236	235
Arcing time	ms	L1	7.72	5.34	4.88	6.60
		L2	7.72	0.40	0.04	1.64
		L3	2.90	5.30	4.86	6.62
Notes		-	-	-	-	-
Evaluation		OK	OK	OK	OK	OK

Evaluation:

OK - The test object was able to make and break properly.

Condition of test object after test:

Immediately after the test of making and breaking capacities, the switching device was capable of properly opening and closing during a no-load operation. The force required for opening measured after the test was 66 N and did not exceed the permissible maximum value of 400 N (one-hand operation, table 17 of IEC 60947-1).

4.3.6.2 TES-1/800

Date of test: 06 August 2021
 Test requirement: Test of making and breaking capacities AC-21B
 Operating cycle: 5 x CO-t (t - dead time)
 Connection of test object: - Power supply at the upper terminals
 - Load circuit at the lower terminals
 Distance of metallic screen from test object: Top: 50 mm, sides: 20 mm
 Condition of test object before test: New

Test parameters:

Test No.	4213965	4213966	4213967	4213968	4213969		
Operating cycle	1. CO-t	2. CO-t	3. CO-t	4. CO-t	5. CO		
Dead time	s	30	30	30	30	-	
Applied voltage	V	850	850	850	850	850	
Prospective peak current	A	L1	543	543	543	543	543
		L2	562	562	562	562	562
		L3	552	552	552	552	552
Prospective test current r.m.s.	A	L1	381	381	381	381	381
		L2	392	392	392	392	392
		L3	390	390	390	390	390
		Average	388	388	388	388	388
Power factor cos φ		0.90	0.90	0.90	0.90	0.90	
Breaking current	A	L1	381	380	379	379	379
		L2	392	392	390	390	390
		L3	390	389	385	388	388
Recovery voltage	V	L1	485	483	485	483	485
		L2	501	500	498	500	497
		L3	485	487	484	483	484
		Average phase-to-phase	849	849	847	846	846
Joule integral	10 ³ A ² s	L1	32.3	31.0	27.1	28.9	37.0
		L2	34.9	32.9	28.1	30.3	37.8
		L3	33.6	32.3	27.9	29.2	37.9
Duration of current flow	ms	221	214	186	196	265	
Arcing time	ms	L1	6.88	13.7	26.6	0.980	3.14
		L2	6.92	18.7	21.6	9.50	2.36
		L3	2.02	18.7	26.3	4.54	3.14
Notes		-	-	-	-	-	
Evaluation		OK	OK	OK	OK	OK	

Evaluation:

OK - The test object was able to make and break properly.

Condition of test object after test:

Immediately after the test of making and breaking capacities, the switching device was capable of properly opening and closing during a no-load operation. The force required for opening measured after the test was 121 N and did not exceed the permissible maximum value of 400 N (one-hand operation, table 17 of IEC 60947-1).

4.4 Dielectric verification

4.4.1 Test laboratory

Low-voltage test laboratory, test room 4

4.4.2 Normative document

IEC 60947-3: 2020-04, Sub-clause 9.3.4.5

4.4.3 Required test parameters

Test voltage: 1600 V ($2 \times U_e$)

Test frequency: 50 Hz

4.4.4 Test arrangement

The test object was disconnected and removed from the equipment for the switching tests.

4.4.5 Test results

Date of test: 10 August 2021

After the test of making and breaking capacities, an AC voltage withstand test was carried out at AC 1600 V.

The test voltage was applied:

- between all the terminals of the main circuit connected together and the enclosure with closed and opened contacts,
- between each pole of the main circuit and the other poles connected together and to the enclosure with closed and opened contacts.

During each test period of 60 s, no disruptive discharges occurred.

4.5 Leakage current

4.5.1 Test laboratory

Low-voltage test laboratory, test room 4

4.5.2 Normative document

IEC 60947-3: 2020-04, Sub-clause 9.3.4.6

4.5.3 Required test parameters

Test voltage: 880 V (1.1 x U_e)

Test frequency: 50 Hz

4.5.4 Test arrangement

See Sub-clause 4.4.4, Sheet 18

4.5.5 Test results

Date of test: 10 August 2021

After the dielectric verification, the leakage current was measured across open contacts and between closed contacts and the enclosure at 110 % rated operational voltage.

The measured leakage current was 4.1 μ A for TES-00/800 and 2.9 μ A for TES-1/800 which is lower than the permissible value of 2 mA.

TEST REPORT NO. 00782-21-0416

4.6 Temperature-rise verification

4.6.1 Test laboratory

Low-voltage test laboratory, test rooms 4 and 7

4.6.2 Normative document

IEC 60947-3: 2020-04, Sub-clause 9.3.4.7

4.6.3 Required test parameters

Test current TES-00/800:	160 A, three-phase
Test current TES-1/800:	250 A, three-phase
Test frequency:	50 Hz

4.6.4 Test arrangement

See Sub-clause 4.1.4, Sheet 7

4.6.5 Test and measuring circuits

See Sub-clause 4.1.5, Sheet 8

4.6.6 Test results

4.6.6.1 TES-00/800

The temperature-rise verification was carried out with THS NH00 fuse links (800V, 160A, gL/gG, 50kA, 12W).

Date of test: 09 August 2021
 Test current: 160 A / 161 A / 161 A
 Test frequency: 50 Hz

Condition of test object: Prestressed
 Ambient air: 26.6 °C

Meas. point/ Phase	Designation	Classification	Material	Final temperature measured [°C]	Final temperature rise [K]	Temperature-rise limit permitted [K]	
1	L1	Upper terminals	Terminal	Copper, silver-coated	85.4	80	
	L2				96.0		
	L3				84.6		
2	L1	Lower terminals	Terminal	Copper, silver-coated	76.4	80	
	L2				79.4		
	L3				69.3		
3	-	Manual operating means	Manual actuator	Insulating material	36.0	9.4	35
4	-	Enclosure on the front side, intended to be touched but not hand hold	Exposed part	Insulating material	63.4	36.8	50
5	-	Enclosure, not touched during normal operation	Exposed part	Insulating material	82.8	56.2	60

The final temperature rise measured did not exceed the permissible temperature-rise limits.

4.6.6.2 TES-1/800

The temperature-rise verification was carried out with THS NH1 fuse links (800V, 250A, gL/gG, 50kA, 23W).

Date of test: 09 August 2021
 Test current: 253 A / 251 A / 252 A
 Test frequency: 50 Hz

Condition of test object: Prestressed
 Ambient air: 26.4 °C

Meas. point/ Phase	Designation	Classification	Material	Final temperature measured [°C]	Final temperature rise [K]	Temperature-rise limit permitted [K]	
1	L1	Upper terminals	Terminal	Copper, silver-coated	66.2	39.8	80
	L2				85.0	58.6	
	L3				70.6	44.2	
2	L1	Lower terminals	Terminal	Copper, silver-coated	53.4	27.0	80
	L2				72.2	45.8	
	L3				59.4	33.0	
3	-	Manual operating means	Manual actuator	Insulating material	31.1	4.7	35
4	-	Enclosure on the front side, intended to be touched but not hand hold	Exposed part	Insulating material	51.8	25.4	50
5	-	Enclosure, not touched during normal operation	Exposed part	Insulating material	48.5	22.1	60

The final temperature rise measured did not exceed the permissible temperature-rise limits.

4.7 Strength of actuator mechanism

4.7.1 Test laboratory

Low-voltage test laboratory, test room 7

4.7.2 Normative document

IEC 60947-3: 2020-04, Sub-clause 9.3.4.8

4.7.3 Required test parameters

Minimum operating force: 150 N

Maximum operating force: 400 N

Test performed: One-hand operation

4.7.4 Test arrangement

The fixed and the moving contact parts of pole L3 were kept closed by bore and split-pin.

4.7.5 Test results

Date of test: 10 August 2021

The force F necessary for opening the test object was measured before the strength of the actuator test and is 52.3 N for TES-00/800 and 133.7 N for TES-1/800.

The actuator of TES-00/800 was subjected to the test force of 157 N ($3 \times F$) according to IEC 60947-1, table 17 (one-hand operation). The force was applied without shock to the actuator in a direction to open the contacts for a period of 10 s.

The actuator of TES-1/800 was subjected to the maximum test force of 400 N according to IEC 60947-1, table 17 (one-hand operation). The force was applied without shock to the actuator in a direction to open the contacts for a period of 10 s.

After the test of strength of actuator mechanism no damage was found on the switch-disconnector. The actuator mechanism did not give "OFF" position when the contacts were held closed.

The position indication complies with the requirements defined in IEC 60947-3, Sub-clause 9.2.6.

5. Photos

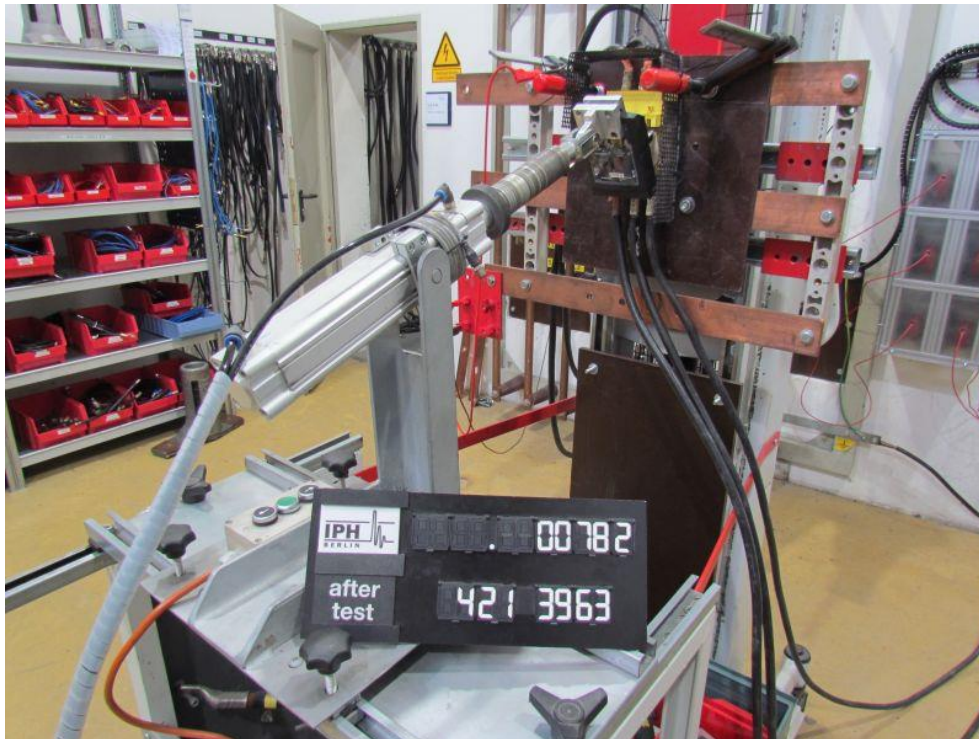

Photo 1: Test object TES-00/800 after the verification of making and breaking capacities

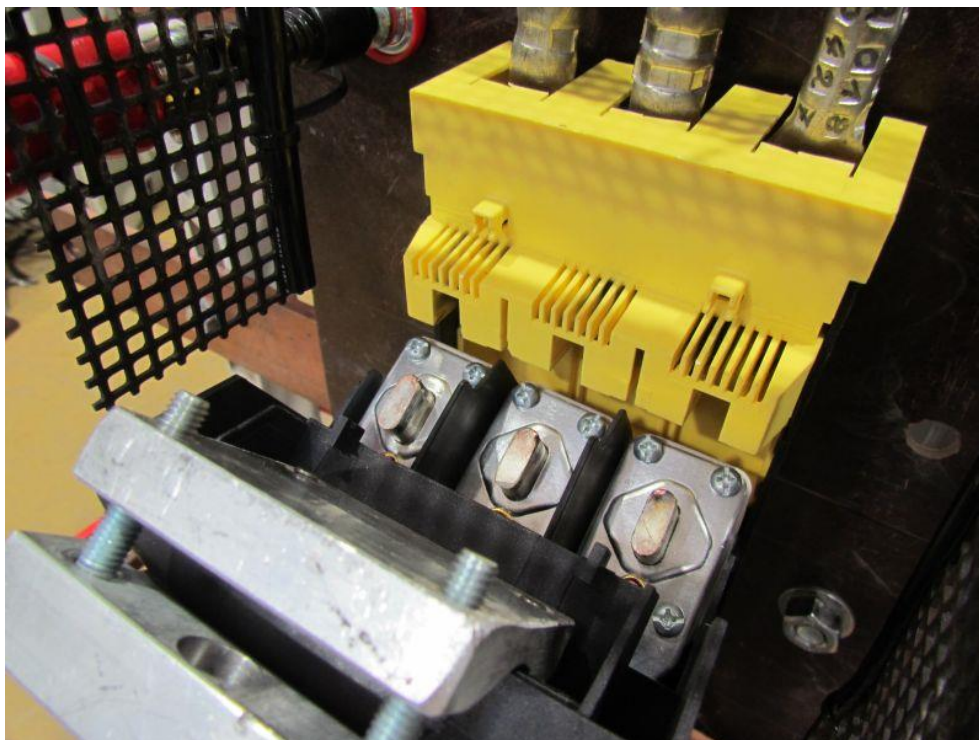

Photo 2: Test object TES-00/800 after the verification of making and breaking capacities

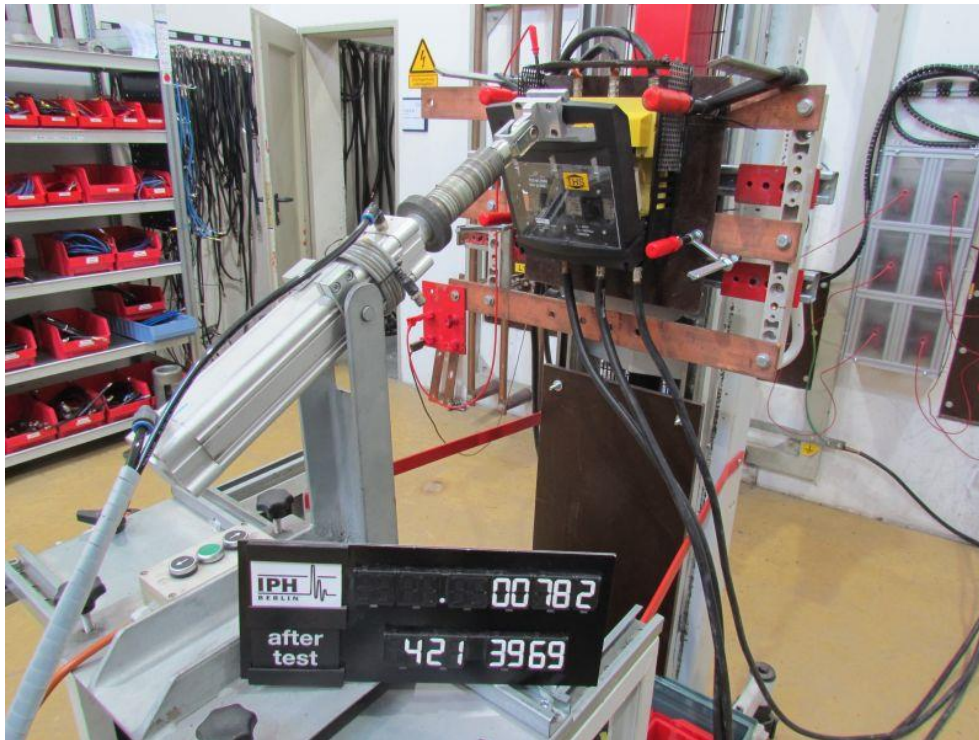

Photo 3: Test object TES-1/800 after the verification of making and breaking capacities

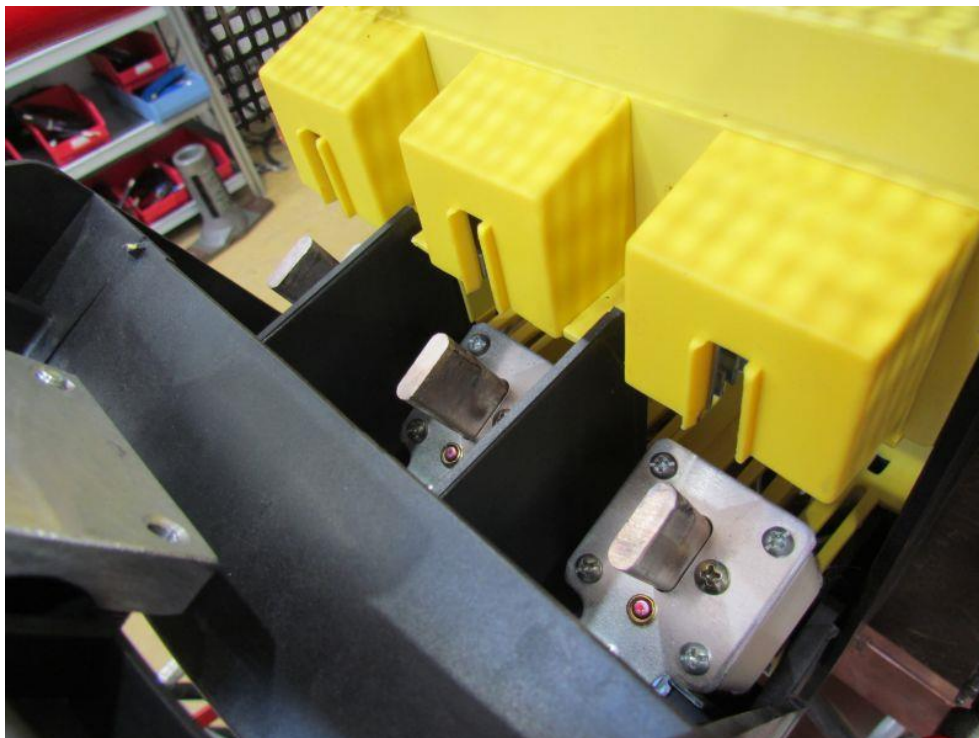

Photo 4: Test object TES-1/800 after the verification of making and breaking capacities

TEST REPORT NO. 00782-21-0416

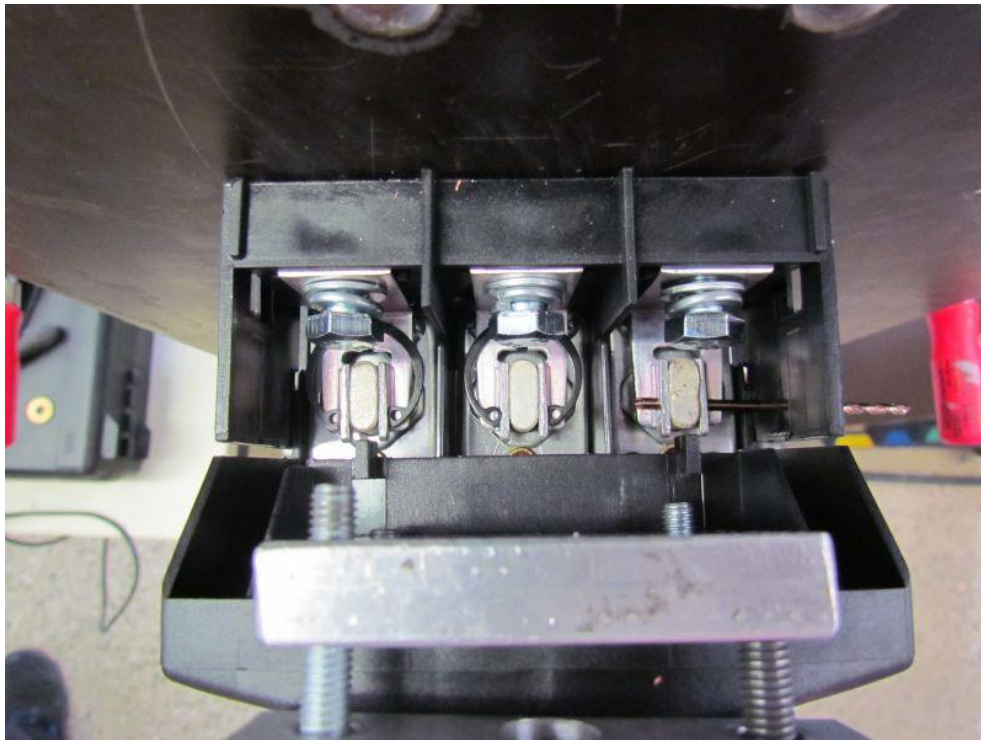

Photo 5: Test object TES-00/800 before the verification of the strength of actuator mechanism

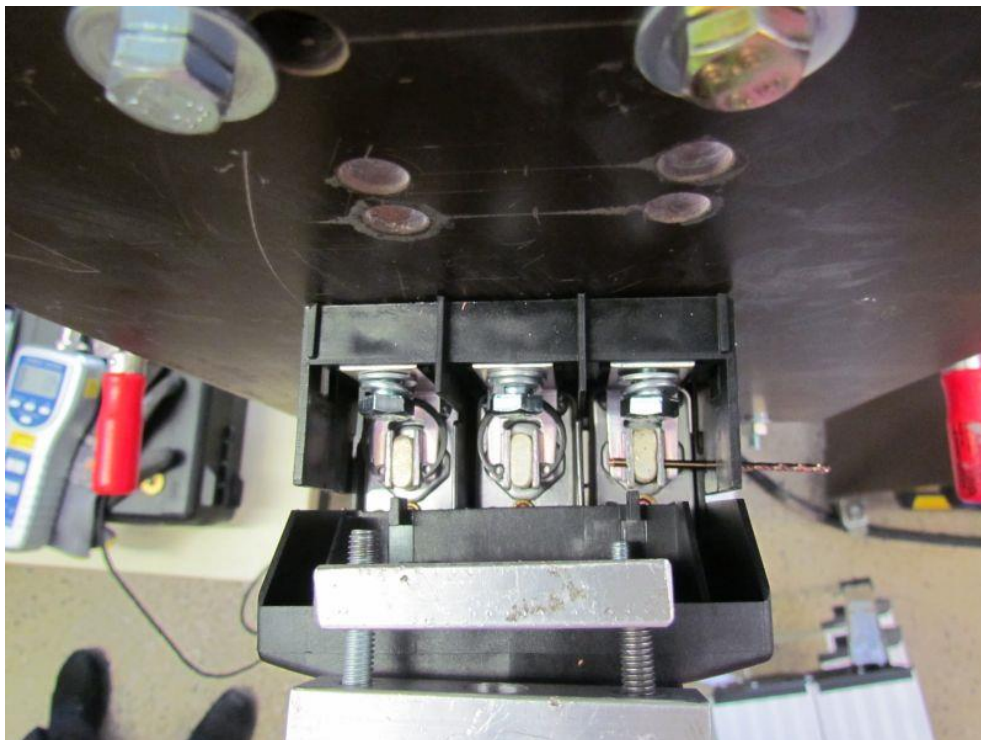

Photo 6: Test object TES-00/800 after the verification of the strength of actuator mechanism



Photo 7: Test object TES-1/800 after the verification of the strength of actuator mechanism

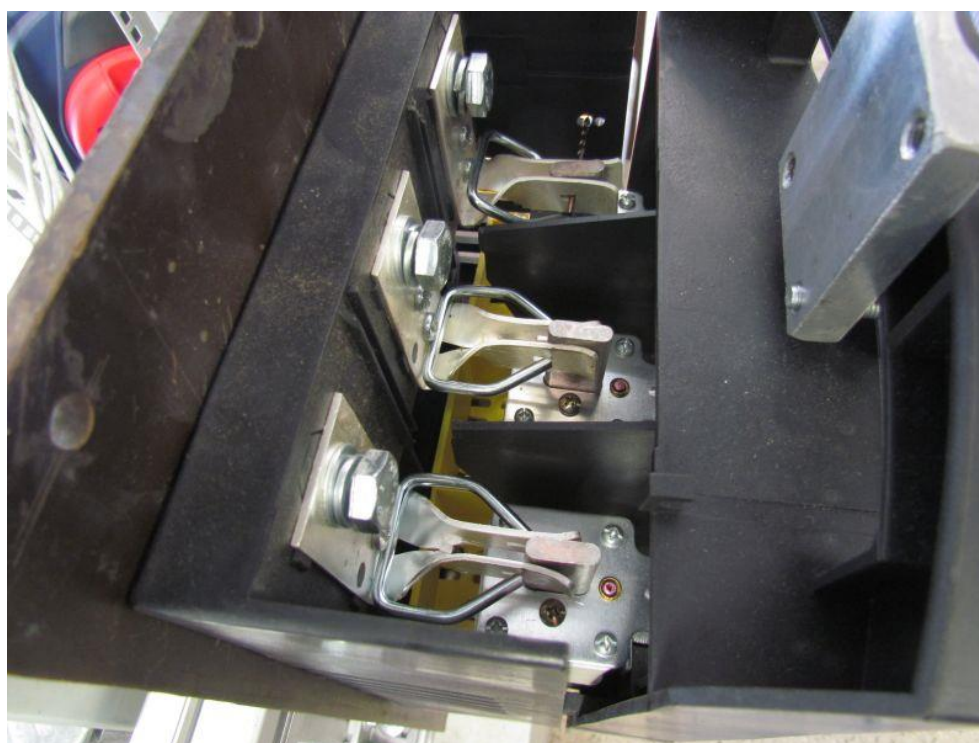

Photo 8: Test object TES-1/800 after the verification of the strength of actuator mechanism



Photo 9: Test object TES-00/800 during temperature-rise verification



Photo 10: Test object TES-1/800 during temperature-rise verification

6. Oscillograms

Test-No. 4213959

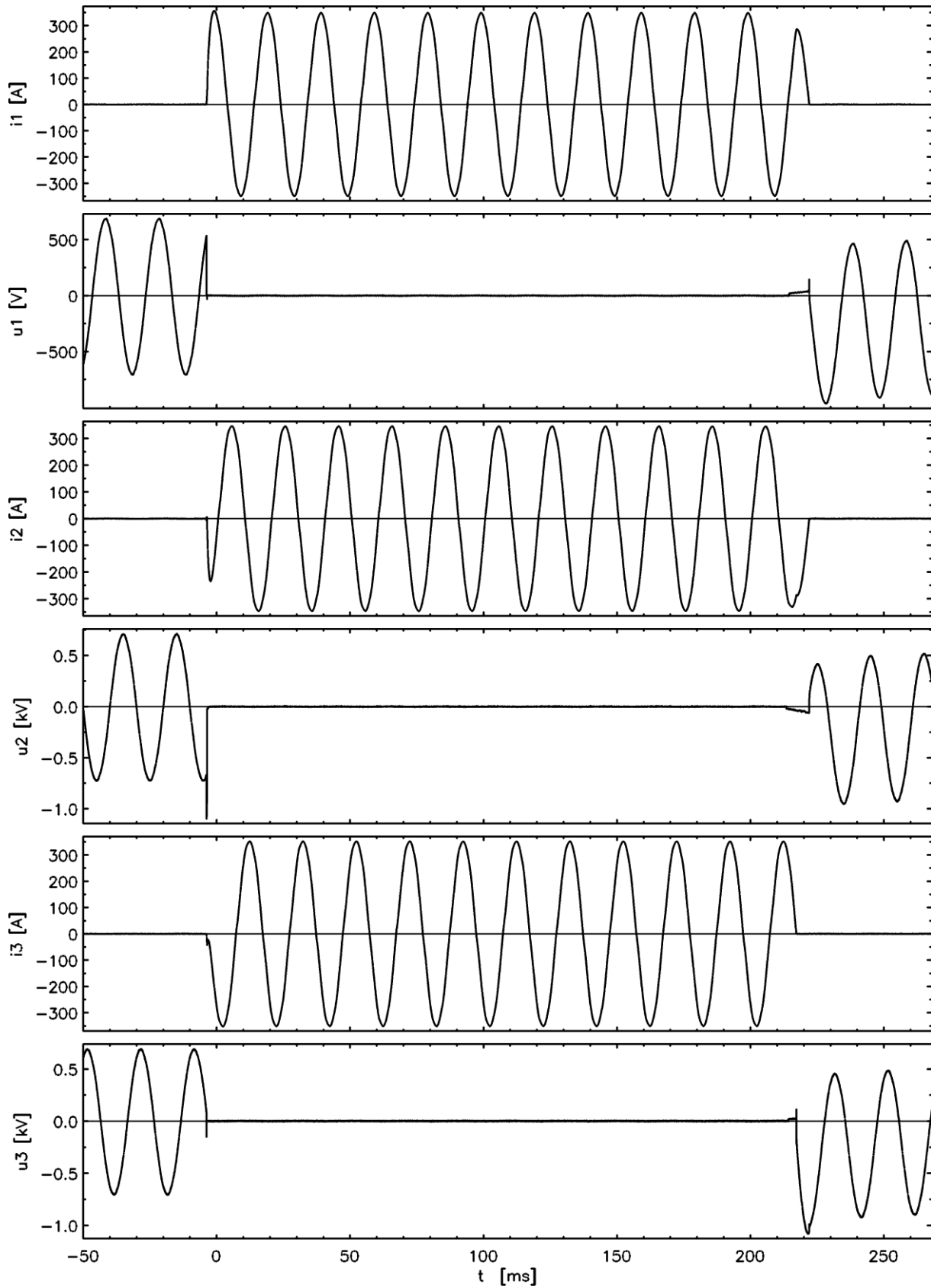

Test-No. 4213960

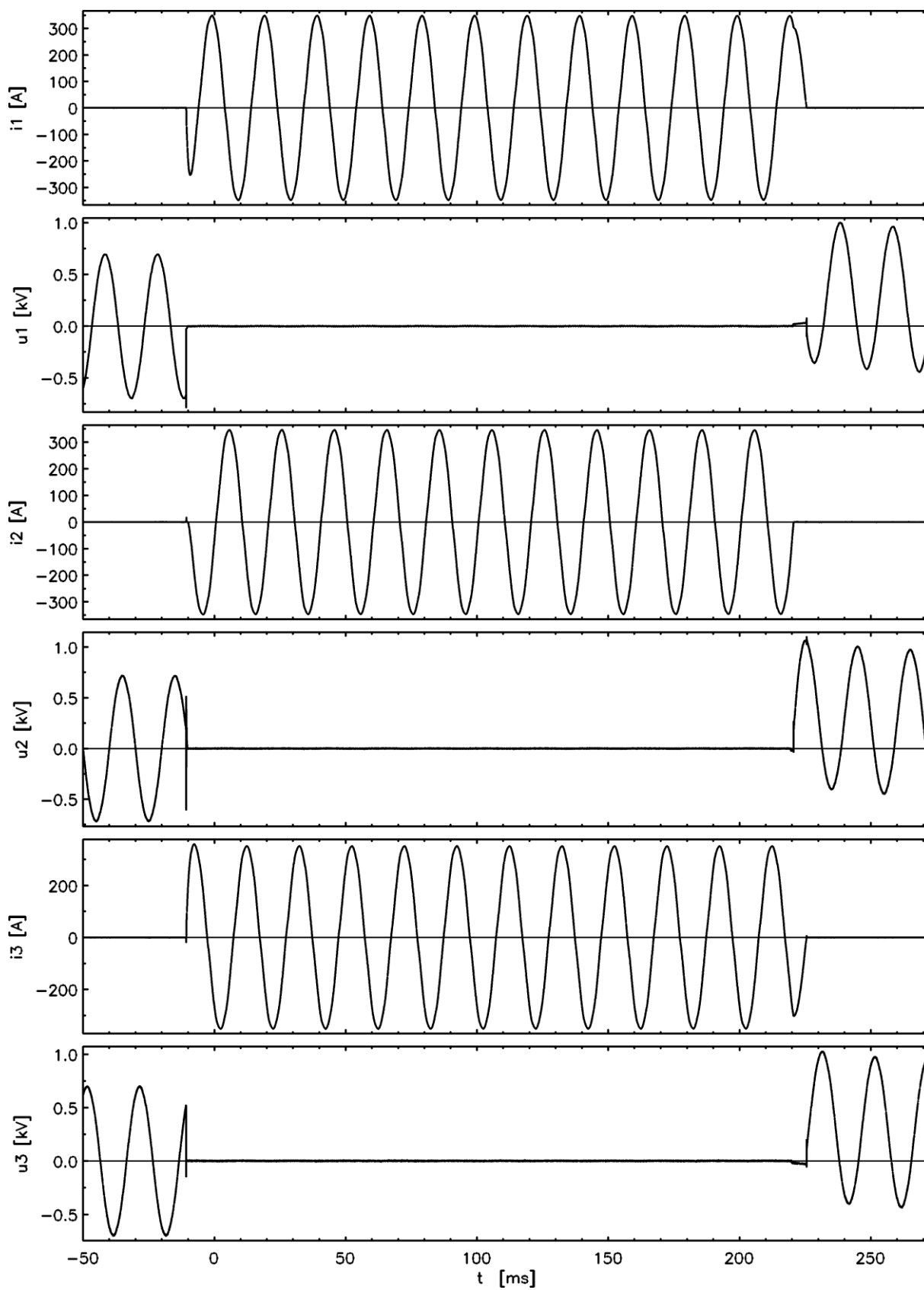

Test-No. 4213961

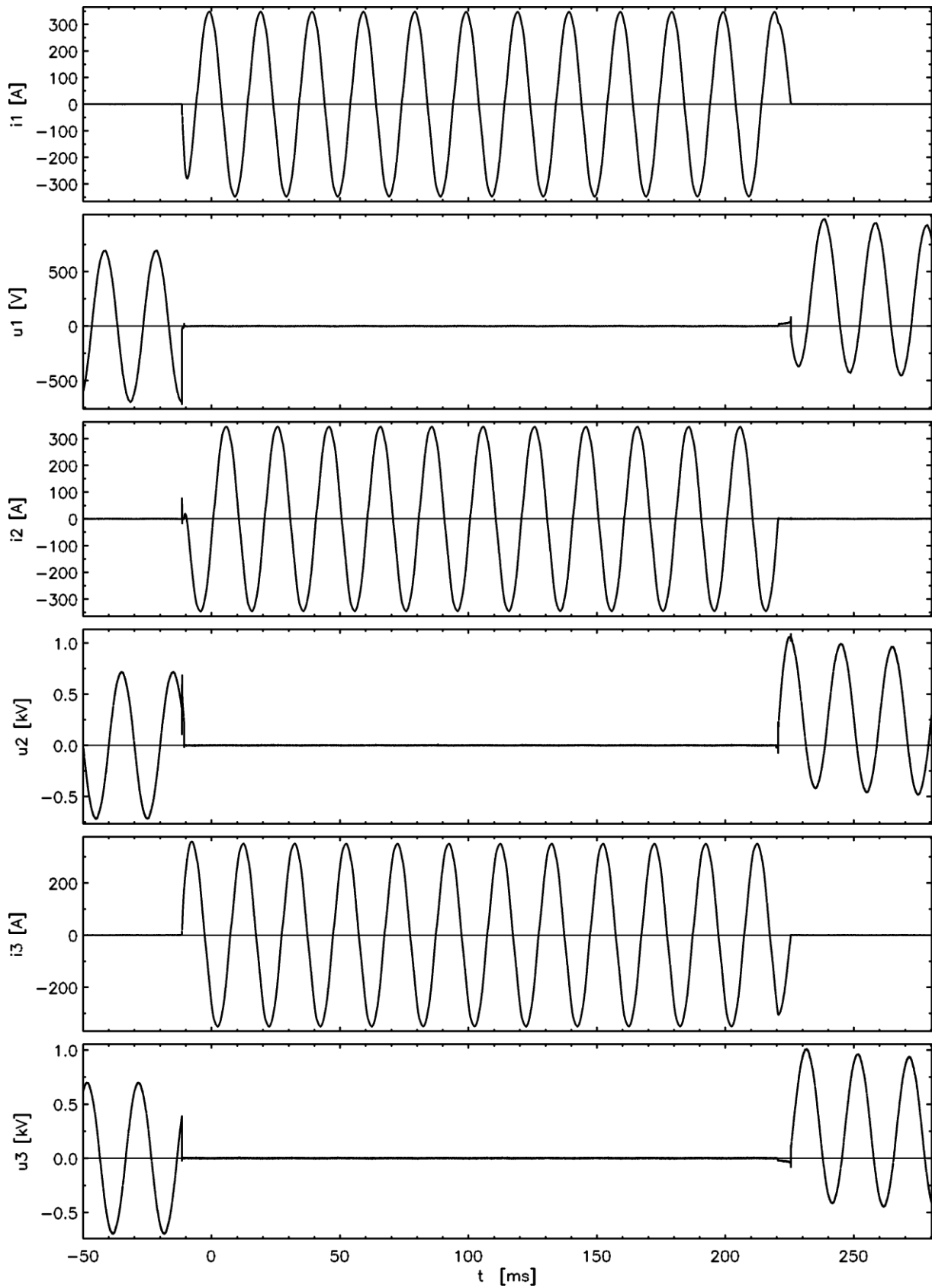

Test-No. 4213962

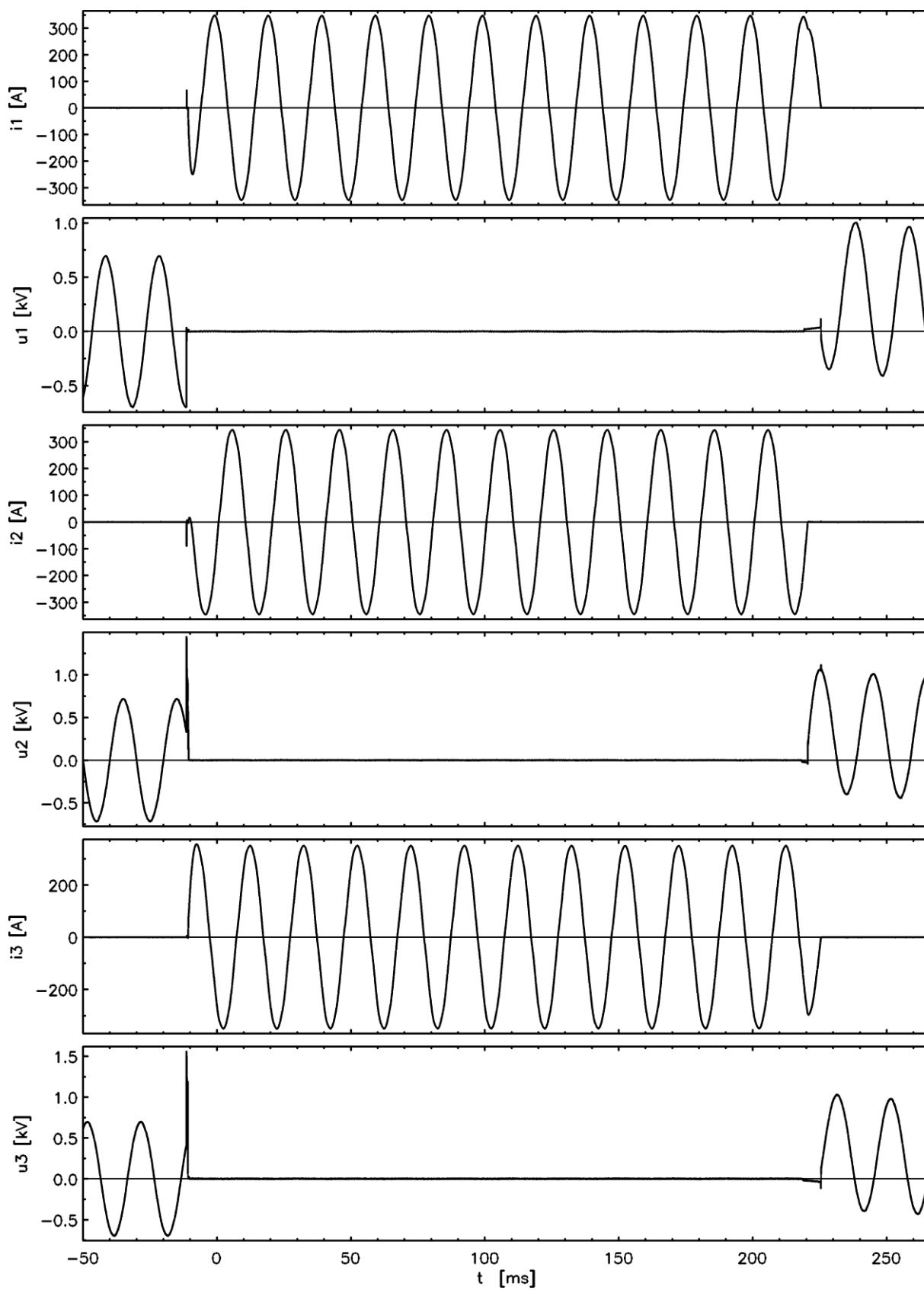

Test-No. 4213963

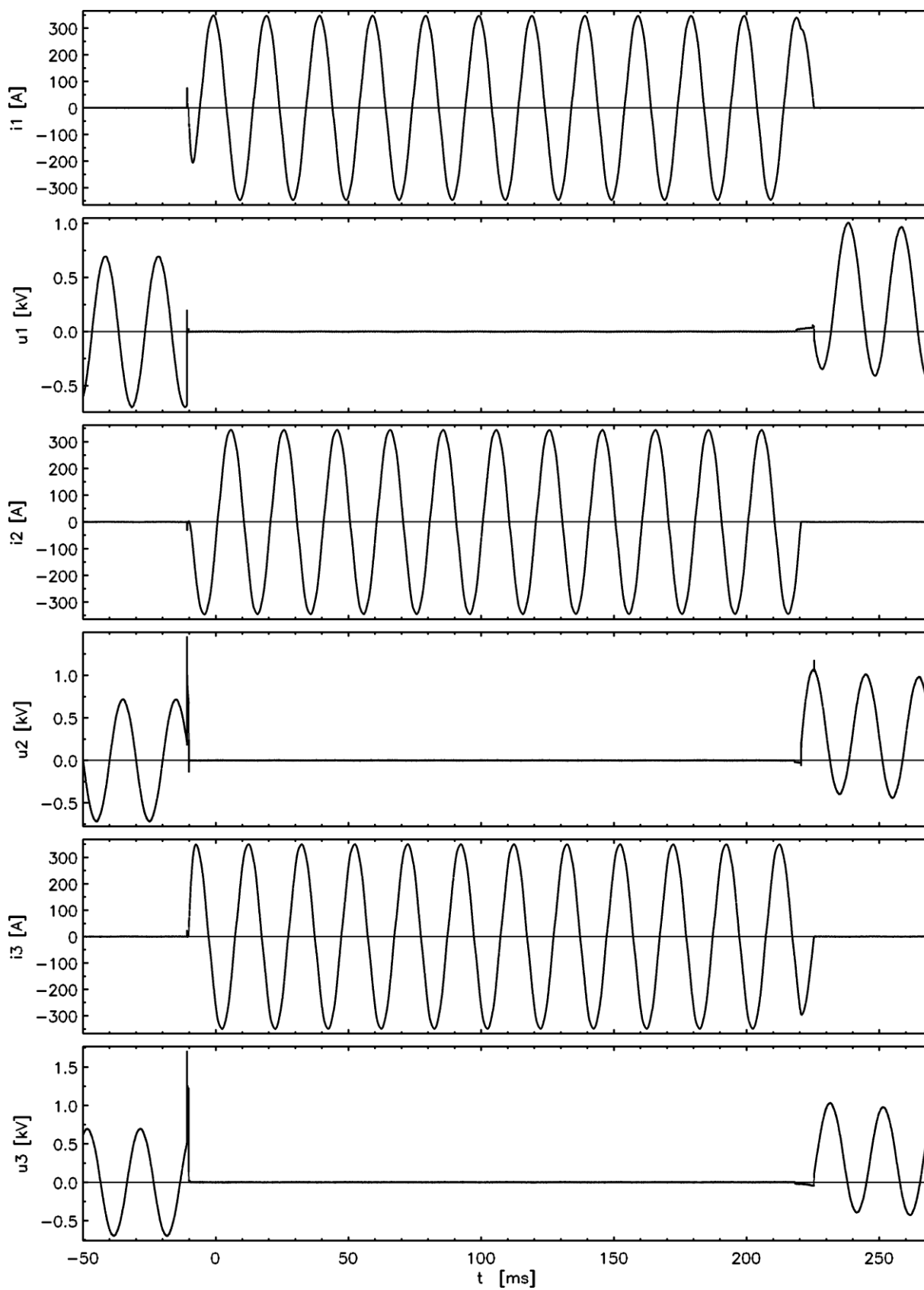

Test-No. 4213965

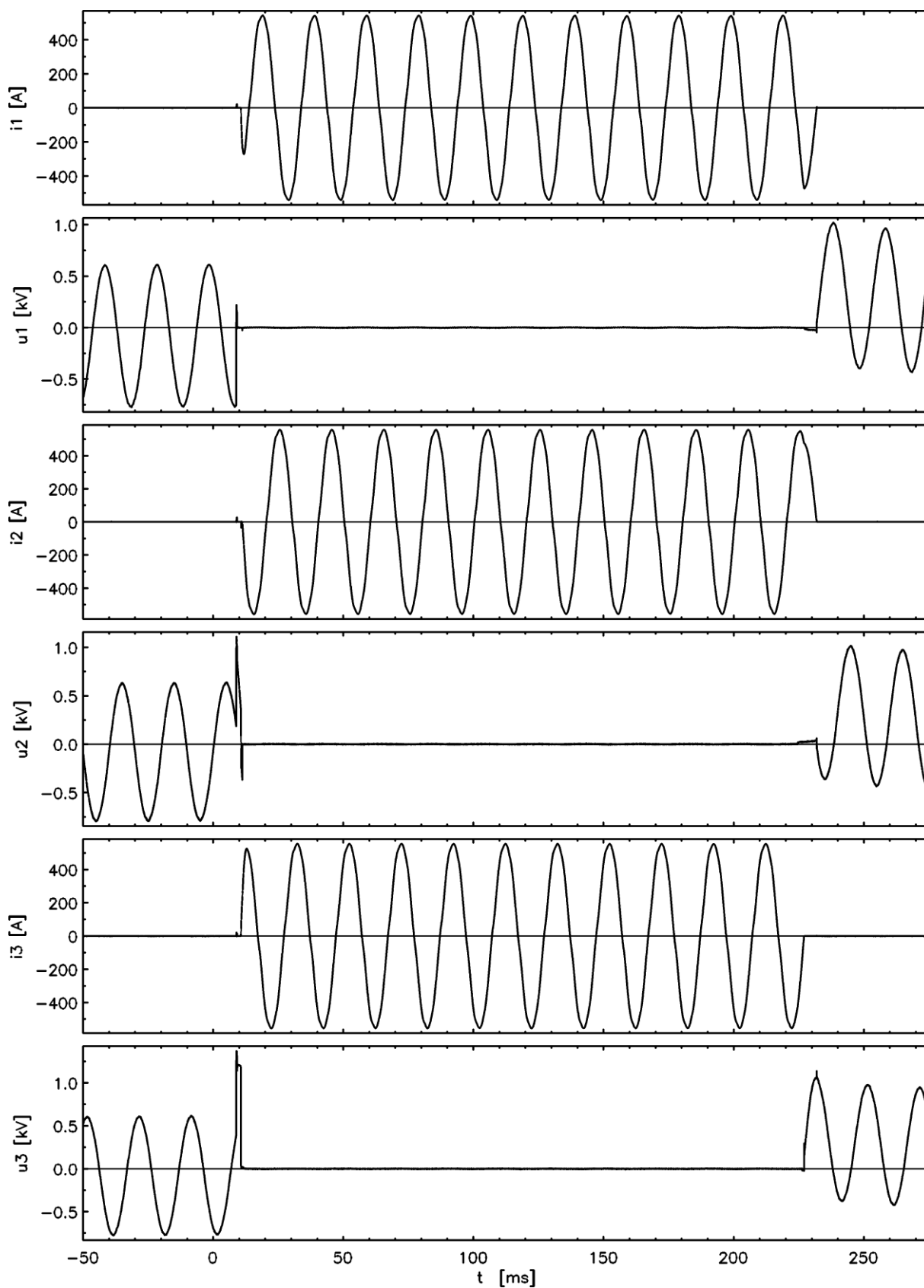

Test-No. 4213966

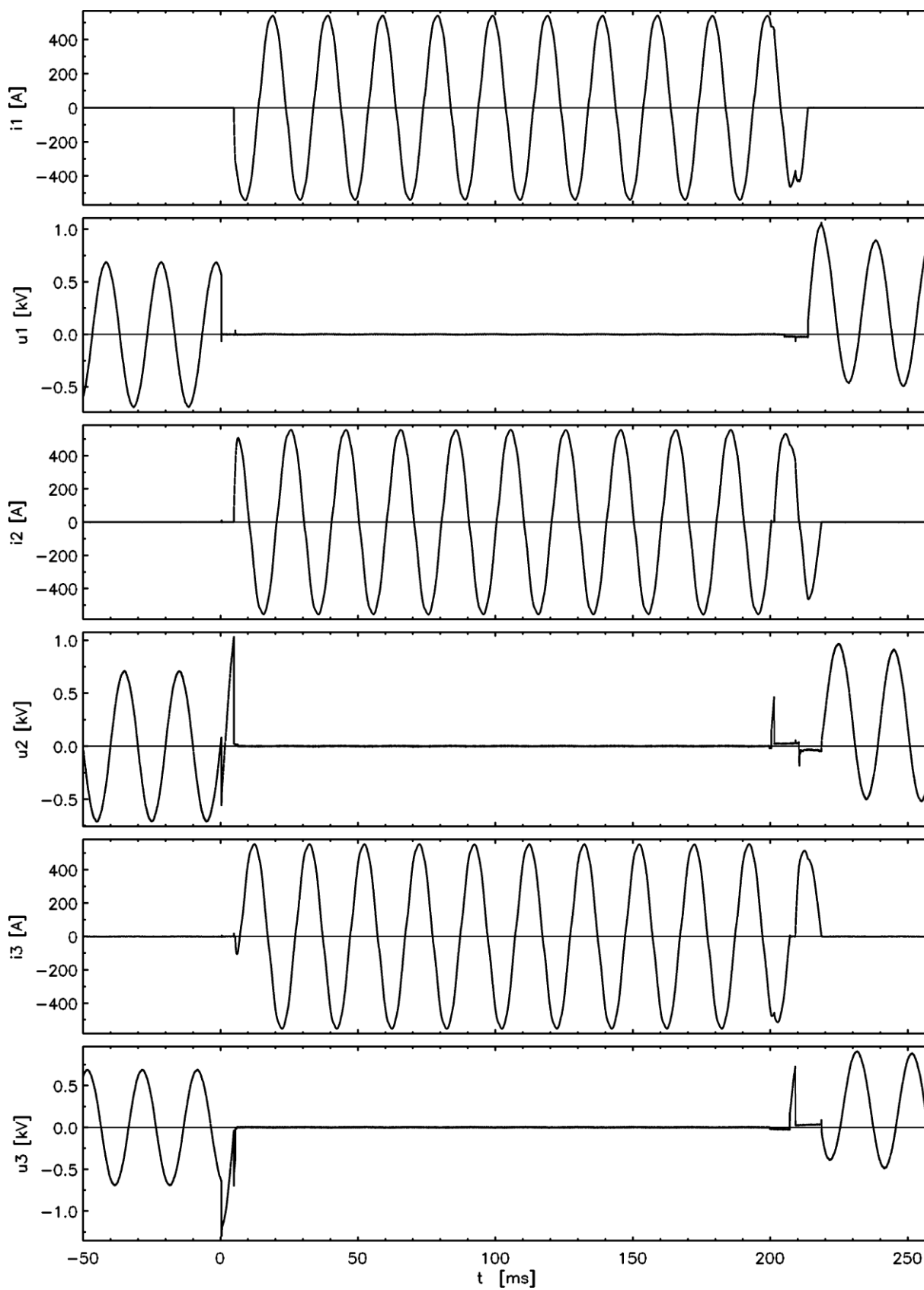

Test-No. 4213967

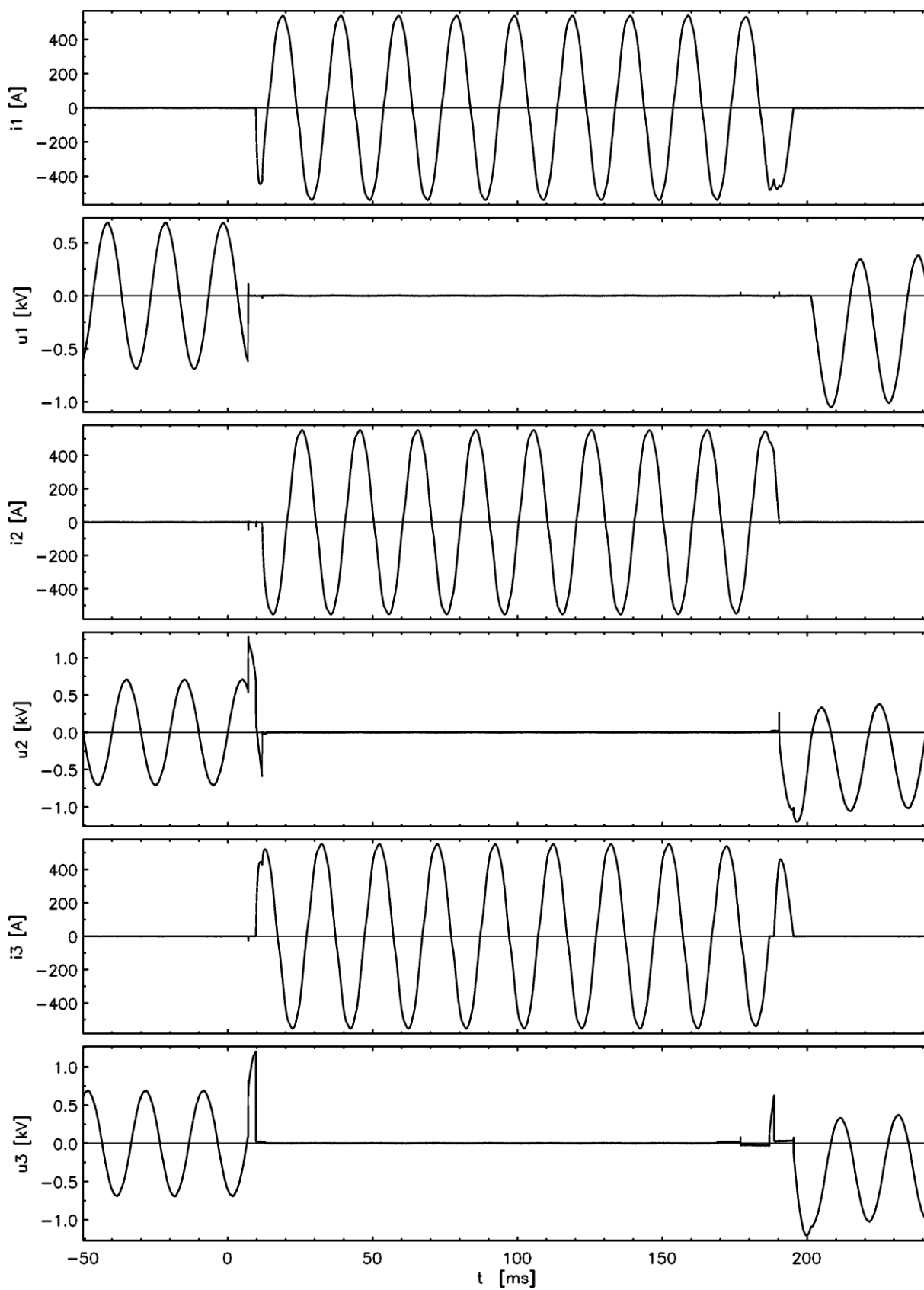

Test-No. 4213968

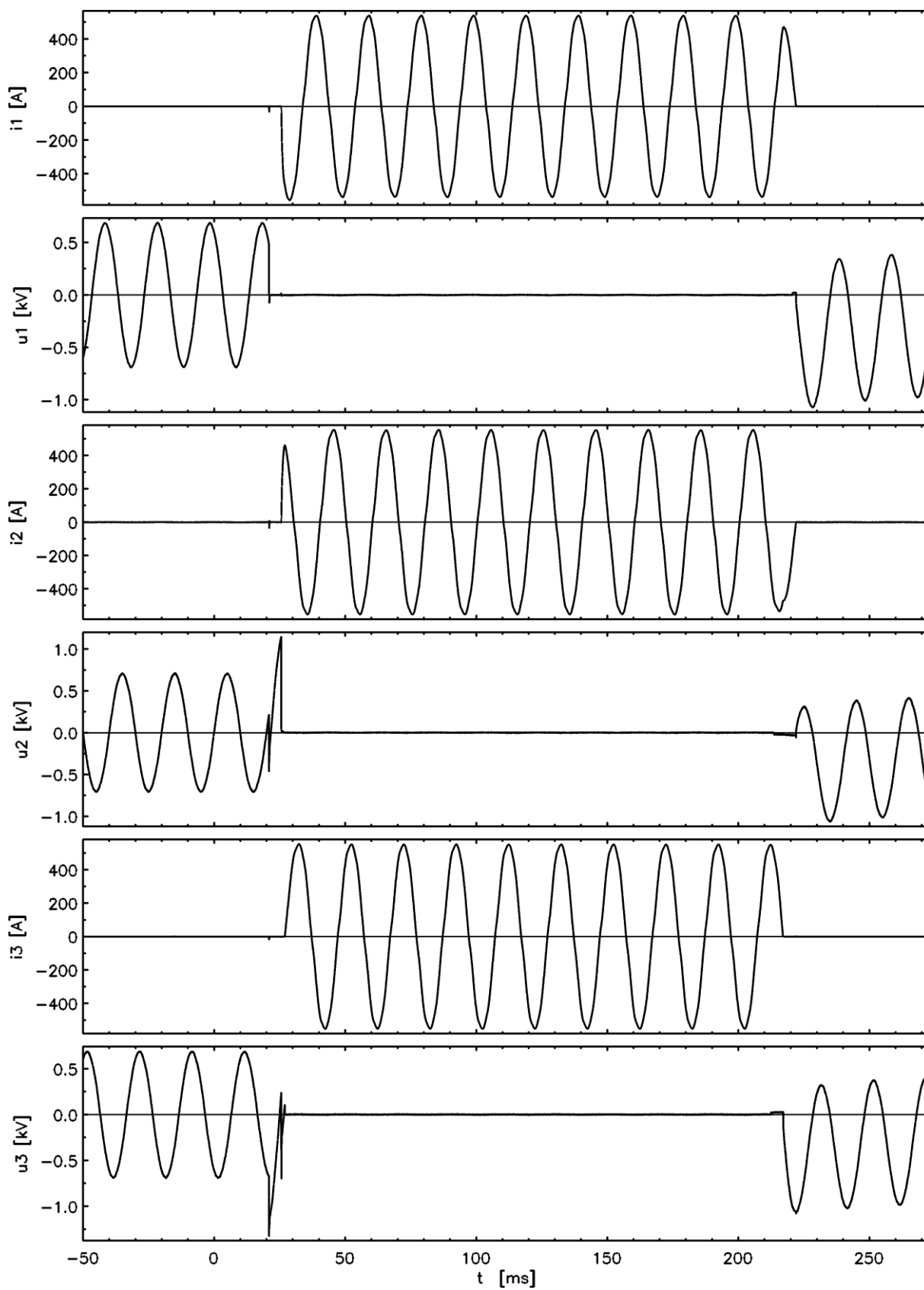

Test-No. 4213969

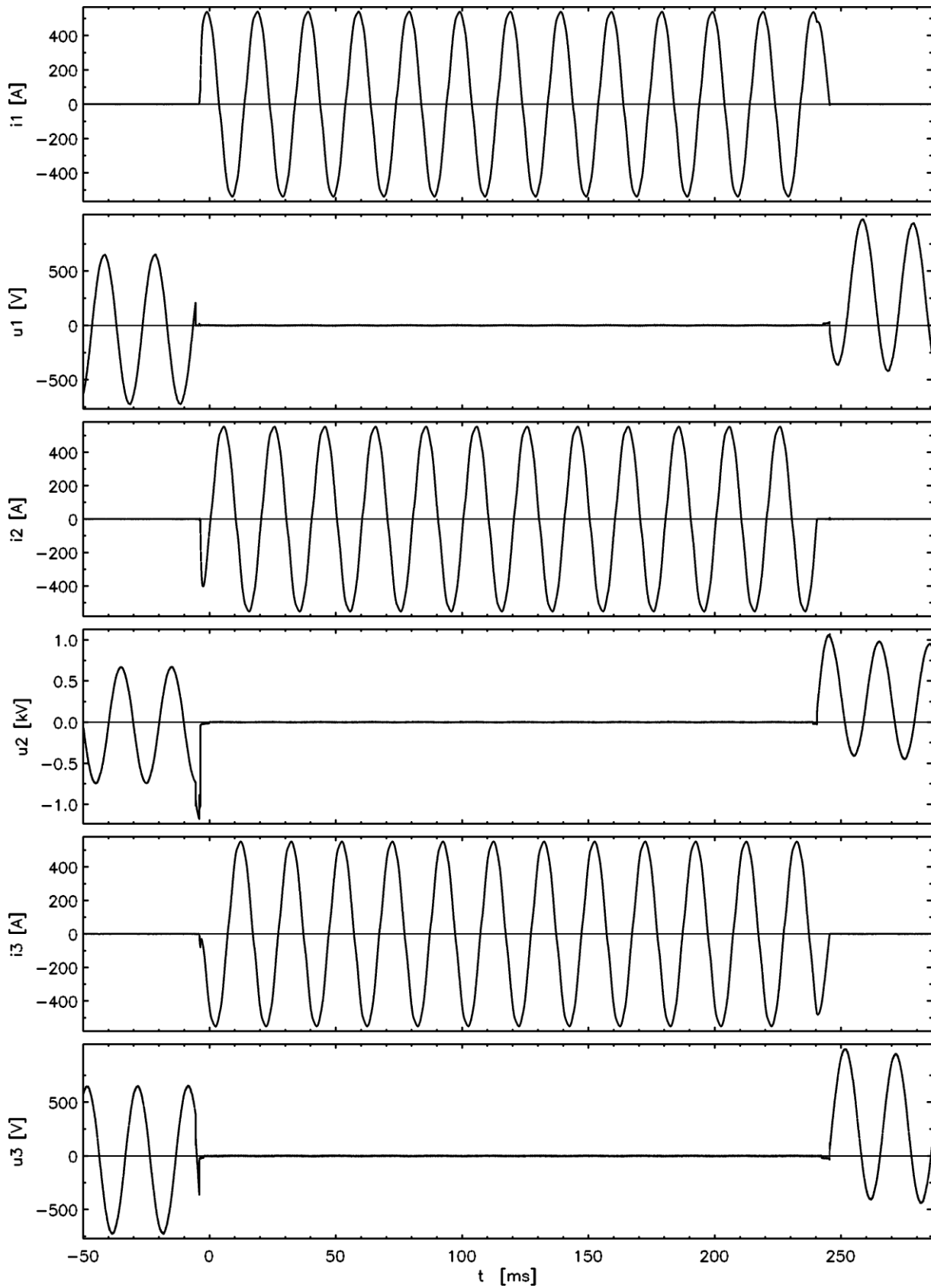

7. Drawings

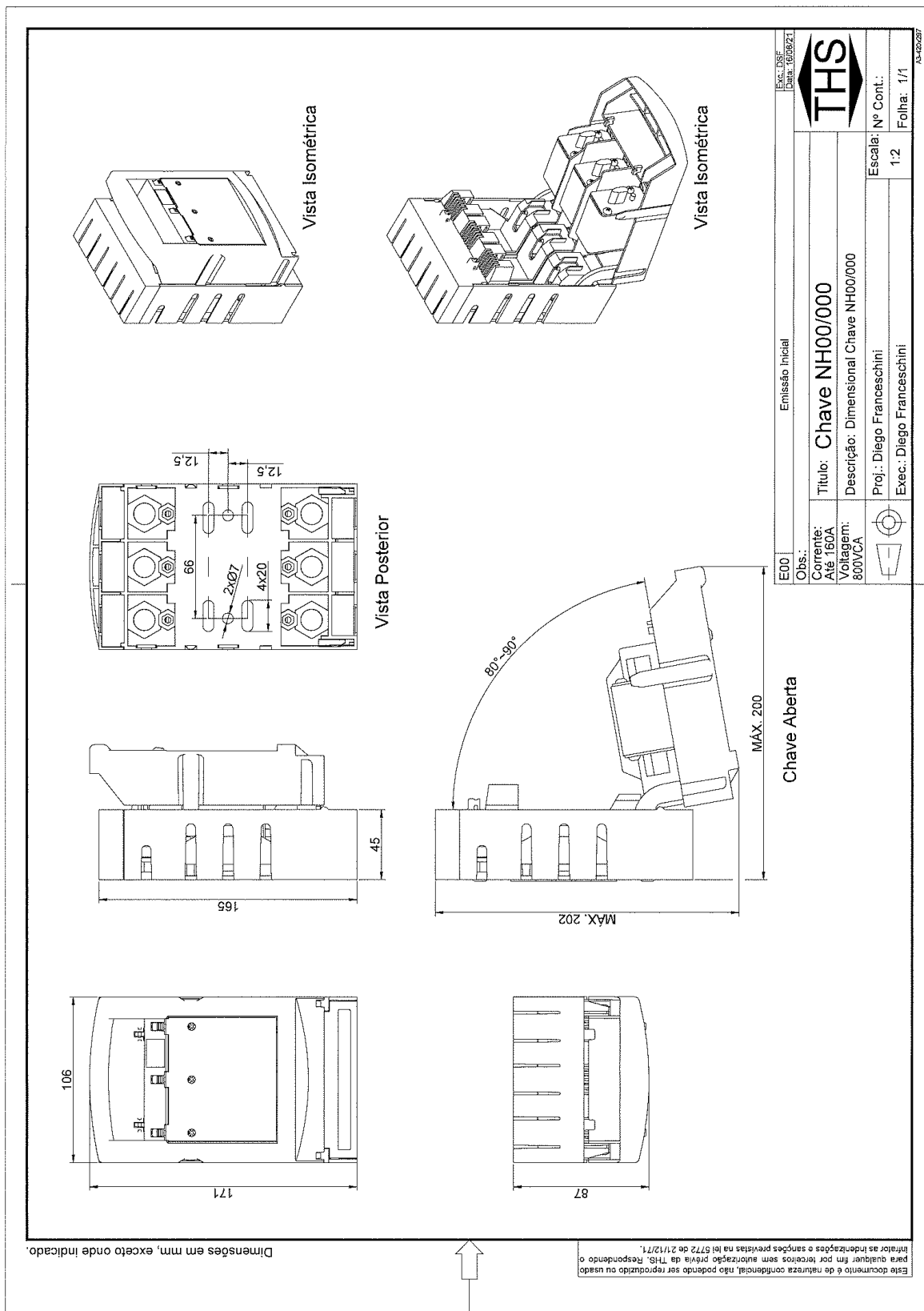

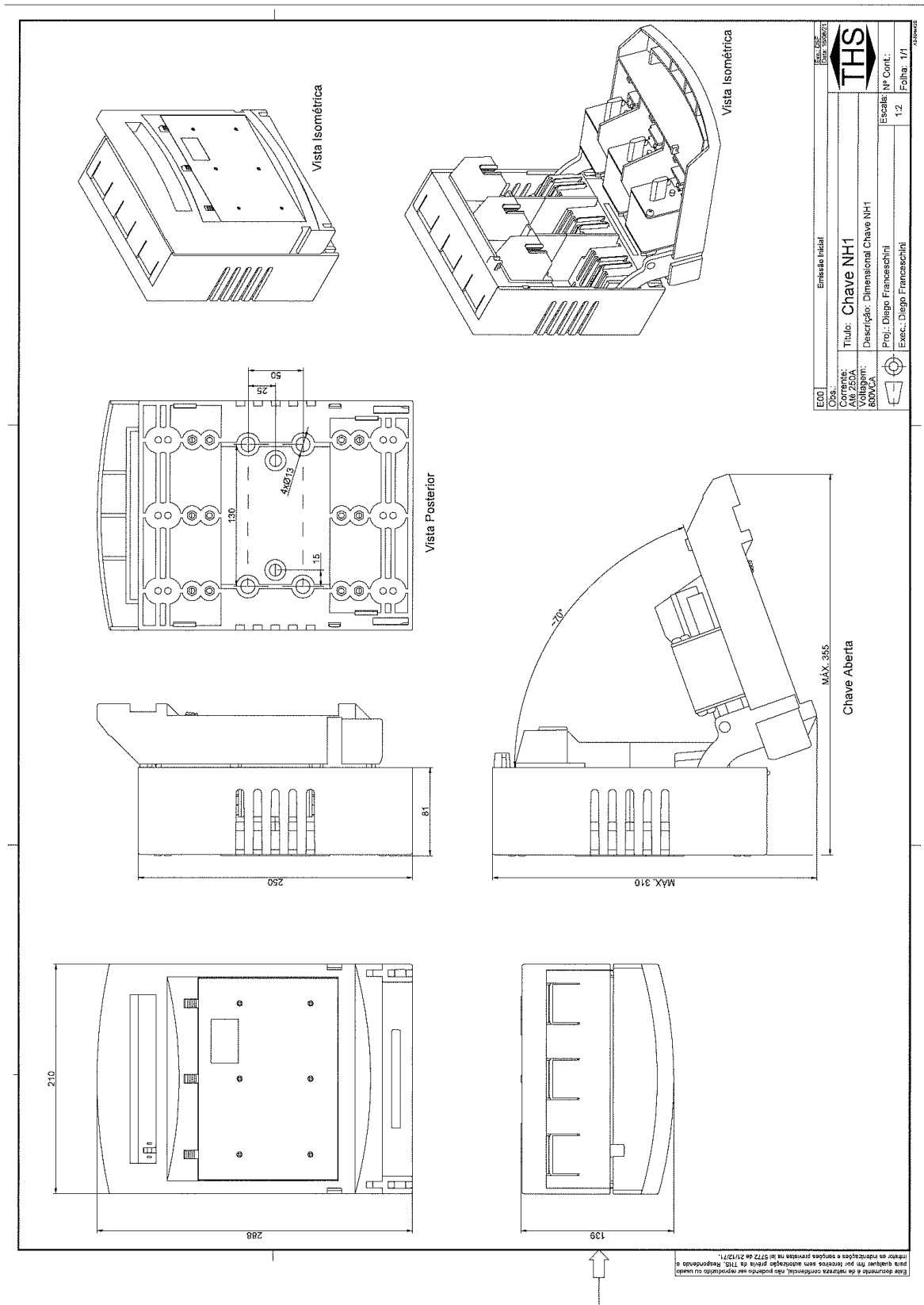

Este documento é matéria confidencial, não podendo ser reproduzido ou usado
 para qualquer fim por terceiros sem autorização expressa do THS. Responsável é
 o THS em conformidade com o Regulamento (UE) 2017/746.

Obs:	Emissão Inicial
E001	
Proj.:	Diogo Franceschini
Exec.:	Diogo Franceschini
Escala:	Nº Cent.: 1,2
Folha:	1/1
	
Título: Chave NH1 Descrição: Dimensional Chave NH1 Voltagem: 250V RPDVCA:	



Soluções criativas para você comutar, selecionar, controlar, ligar, e proteger seus processos industriais

SECCIONADORA NH TES/800V - SOB CARGA

LINHA TES/800VCA

Vantagens:

- Alta segurança na operação.
- Dimensões reduzidas.
- Ótimo Custo x Benefício.
- Facilidade na instalação.

Para aplicações de distribuição de energia até 800Vca e correntes entre 160A à 250A. As seccionadoras TES da THS operam em conjunto com os fusíveis NH 000, 00 e1 instalados por engate rápido na seccionadora.

A seccionadora TES operando em tensões mais elevadas proporcionam menor perda na transmissão, menor custo com cabeamento, limitando assim o risco de possíveis falhas no sistema.

Com um designer moderno e materiais de engenharia, proporcionam um excelente desempenho técnico em uma elevada gama de aplicações.

CORRENTE: 160 a 250A

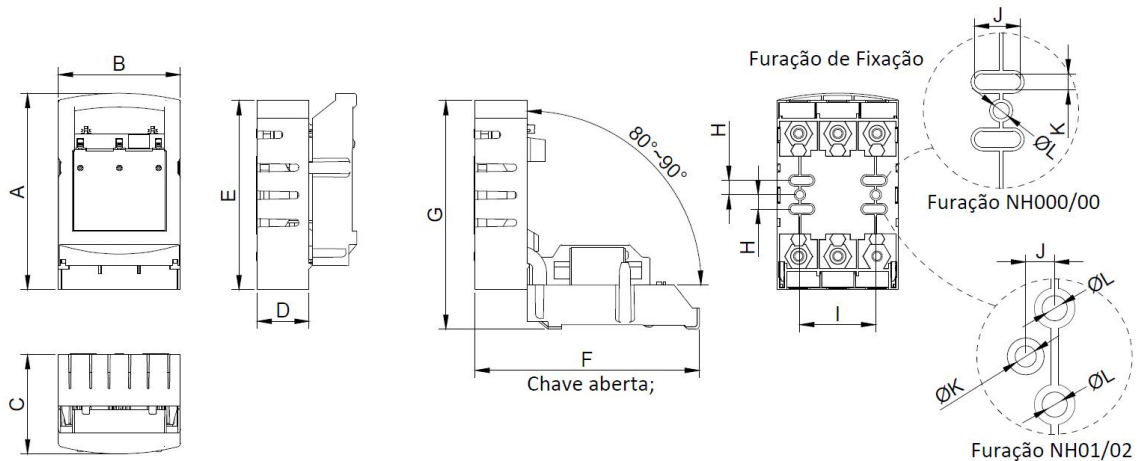

Modelo	A	B	C	D	E	F	G	H	I	J	K	L
TES-NH00/000	171	106	87	45	165	200	202	12,5	66	20	7	7
TES-NH1	288	210	139	81	250	355	310	25	130	15	11	13



SEGURANÇA | TECNOLOGIA | EXPERIÊNCIA | QUALIDADE

Test Report

Document No.	02617-22-0038	Copy No.	1	Number of pages	23
Apparatus	LV-Photovoltaic Fuse				
Designation	1. NH03-630 A and 500 A gL/gG 2. NH02-400 A; 350 A; 315 A; 250 A and 200 A gL/gG 3. NH01-160 A gL/gG 4. NH00-160 A gL/gG				
Serial Number	Test samples				
Manufacturer	THS Industria e Comercio Ltda. Rua Sargento Francisco Rodrigues da Rosa, 534 - Cajuru do Sul Sorocaba – Sao Paulo, 18105-008 BRAZIL				
Client	THS Industria e Comercio Ltda. R. Francisco Rodrigues da Rosa, 534 - Cajuru do Sul Sorocaba - Sao Paulo, 18105-008 BRAZIL				
Date(s) of test(s)	07 February 2022				
Tested by	IPH Institut „Prüffeld für elektrische Hochleistungstechnik“ GmbH Landsberger Allee 378A 12681 Berlin GERMANY				
Test(s) performed	Verification of breaking capacity (Test duty I1) at 800 V a.c.				

The apparatus, constructed in accordance with the description, drawings and photographs incorporated in this document has been subjected to the series of proving tests in accordance with: IEC 60269-2: 2013+AMD1: 2016

The fuses were capable of correctly breaking.

The results are documented in this test report. The ratings assigned by the Manufacturer are listed on the ratings page. The document applies only to the apparatus tested. The responsibility for conformity of any apparatus having the same designations with that tested rests with the Manufacturer.

17 February 2022

Date

 Christian Kruscha
 Test Engineer in charge

 Stefan Schwanck
 Approved by

Partial reproduction of this document is permitted only with the written permissions from CESI Group. The authenticity of this document is guaranteed by the integrity of hologram.

测思 CENTRO
 ELETTROTECNICO
 Sperimentale
 ITALIANO



CESI

Trust the Power of Experience

Notes

STL-Member

CESI Group members are founder members of the SHORT-CIRCUIT TESTING LIAISON (STL) which has been established in 1969. STL is a forum for voluntary international cooperation of testing organizations.

CESI Group Test Documents description

Type Test Certificate of

Issued for type tests of high voltage products ($> 1 \text{ kV}_{ac}$; $> 1,5 \text{ kV}_{dc}$), which have successfully been carried out in full compliance with the relevant specifications or standards and STL Guides valid at the time of the test. The Type Test Certificate consists of documents unequivocally identifying the test object and describes all conditions under which the tests were conducted. It gives evidence of the unobjectionable behavior of the test object during the tests in line with the normative documents applied as well as of the results of successful testing.

Test Certificate of (complete / selected) Type Tests

Issued if type tests of low voltage products ($< 1 \text{ kV}_{ac}$; $< 1,5 \text{ kV}_{dc}$) requested by the relevant product standard were passed. For these tests the equipment under test must be clearly identified by technical description, drawings, and additional specifications.

Certificate of Design Verification

Issued for passed design verification tests according to IEC 61439. For these tests the equipment under test must be clearly identified by technical description, drawings, and additional specifications.

Type Test Report

Issued for high and low voltage products if parts of selected type tests have been passed; those shall be carried out in full compliance with the relevant standards but (for high voltage products) do not fulfill all STL requirements for issuing a Type Test Certificate. For these tests the equipment under test must be clearly identified by technical description, drawings, and additional specifications.

Test Report

Issued for all other tests on high and low voltage products which have been carried out according to specifications, standards and/or client instructions

On-Site Test Record

Issued as a record of results acquired during the on-site tests / measurements

Test Award

Can be additionally issued for all named types of test documents above if the tests to be referenced were passed

Contents	Sheet
1. Present at the test.....	4
2. Test performed.....	4
3. Verification of breaking capacity	5
3.1 Test laboratory	5
3.2 Normative document.....	5
3.3 Required test parameters	5
3.4 Test arrangement.....	5
3.5 Test and measuring circuits.....	6
3.6 Test results.....	7
4. Photographs.....	10
5. Oscillograms.....	11
6. Drawings / technical data sheets (provided by the client)	22

TEST REPORT NO. 02617-22-0038

1. Present at the test

Mr. Kruscha IPH test engineer in charge

2. Test performed

Verification of breaking capacity (Test duty I1) at 800 V a.c.

3. Verification of breaking capacity

3.1 Test laboratory

High-power test laboratory, high-current test bay

3.2 Normative document

IEC 60269-2: 2013+AMD1: 2016

3.3 Required test parameters

Power-frequency recovery voltage	V	800
Prospective current	kA	50
Initiation of arcing after voltage zero		65 ... 90° el
Power factor		0.1 to 0.2
Test frequency	Hz	50
Maintained voltage after breaking	s	≥ 15
Number of tests		1 test for each test sample

3.4 Test arrangement

The breaking tests were performed with single-phase alternating current and with a single fuse. The fuse to be tested was mounted on a test rack in the normal service position.

3.5 Test and measuring circuits

Technical data of test circuits

Test requirement	Verification of breaking capacity	
Test No.	122 0674 to 122 0684	
Number of phases (Test circuit)	2	
Number of poles/phases (Test object)	1	
Test frequency Hz	50	
Earthing conditions	Generator, grid	Not earthed
	Short-circuit transformers	Earthed

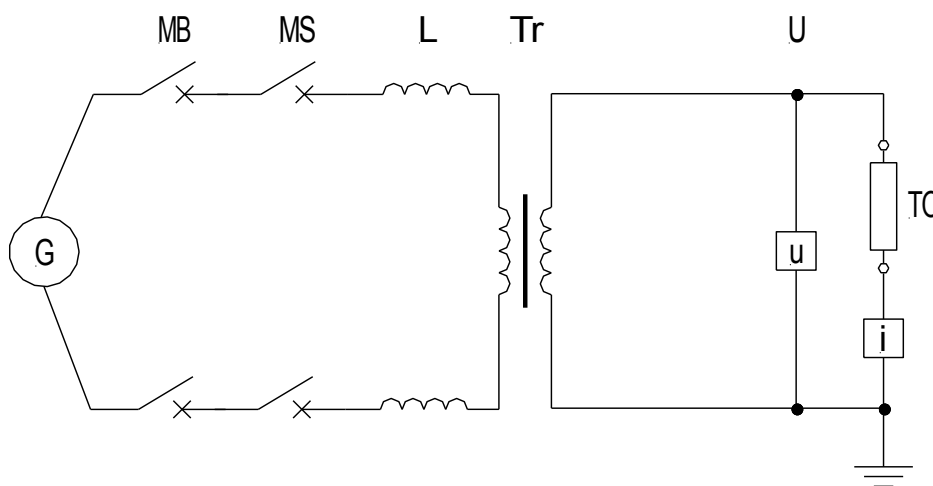

- | | | | |
|----|--------------------------|----|---------------------------|
| E | Power supply | Tr | Short-circuit transformer |
| MB | Master breaker | i | Current measurement |
| MS | Making switch | u | Voltage measurement |
| L | Current limiting reactor | | |

Figure 1: Test circuit diagram

Technical data of measuring circuits

Measuring point	Symbol in the oscillograms	Measuring quantity	Measuring sensor/device
1	i	Breaking current	Rogowski measuring device
2	u	Voltage	RC divider
Recording instrument: AD3000 multichannel transient recorder system			

3.6 Test results

Test requirement: Test duty I1
 Condition of test object before test: New
 Type: NH00 63 A gG

Test No.	122	0675	0676	0677
Test sample No.		1	2	3
Type of of fuse-link		NH3	NH3	NH2
Rated current of fuse-link	A	630	500	350
Test voltage	V	800	800	800
Prospective peak current	kA	107	107	107
Prospective breaking current I_p	kA	51.9	51.9	51.9
Power factor $\cos \varphi$		0.25	0.25	0.25
Making angle	°el.	62.6	51.6	47.2
Initiation of arcing after voltage zero	°el.	97.6	85.4	71.0
Melting current i_s	kA	41.5	38.5	25.9
Cut-off current	kA	41.9	39.0	25.6
Melting time	ms	1.93	1.87	1.32
Arcing time	ms	3.68	4.21	4.74
Operating time	ms	5.62	6.09	6.07
Melting integral	10^3 A ² s	1169	936	292
Arcing integral	10^3 A ² s	1760	1577	655
Operating integral	10^3 A ² s	2929	2513	947
Arcing energy	kVAs	93.9	93.8	57.8
Peak switching voltage	kV	1.77	1.81	1.71
Recovery voltage	V	823	819	818
Duration of power frequency recovery voltage	s	15	15	15
Fuse operated correct	y/n	y	y	y
Emission of flames or sand	y/n	n	n	n
Damages (external)	y/n	n	n	n
Operation of striker correct	y/n	y	y	y
Evaluation		OK	OK	OK

Notes:

OK - The fuse is capable of correctly breaking the prospective current

Test No. 122 0674: Current setting

TEST REPORT NO. 02617-22-0038

Test results (continued)

Test requirement: Test duty I1
 Condition of test object before test: New
 Type: NH00 63 A gG

Test No.	122	0678	0679	0680
Test sample No.		4	5	6
Type of of fuse-link		NH2	NH2	NH2
Rated current of fuse-link	A	315	400	250
Test voltage	V	800	800	800
Prospective peak current	kA	107	107	107
Prospective breaking current I_p	kA	51.9	51.9	51.9
Power factor $\cos \varphi$		0.25	0.25	0.25
Making angle	°el.	57.8	58.1	51.8
Initiation of arcing after voltage zero	°el.	78.4	82.8	70.2
Melting current i_s	kA	24.4	29.4	20.5
Cut-off current	kA	25.0	29.1	20.9
Melting time	ms	1.14	1.37	1.02
Arcing time	ms	4.46	4.26	4.68
Operating time	ms	5.60	5.63	5.69
Melting integral	$10^3 \text{ A}^2\text{s}$	229	400	141
Arcing integral	$10^3 \text{ A}^2\text{s}$	624	866	396
Operating integral	$10^3 \text{ A}^2\text{s}$	853	1266	537
Arcing energy	kVAs	53.5	65.2	42.5
Peak switching voltage	kV	1.67	1.74	1.64
Recovery voltage	V	820	821	819
Duration of power frequency recovery voltage	s	15	15	15
Fuse operated correct	y/n	y	y	y
Emission of flames or sand	y/n	n	n	n
Damages (external)	y/n	n	n	n
Operation of striker correct	y/n	y	y	y
Evaluation		OK	OK	OK

Notes:

OK - The fuse is capable of correctly breaking the prospective current

Test results (continued)

Test requirement: Test duty I1
 Condition of test object before test: New
 Type: NH00 63 A gG

Test No.	122	0681	0682	0683
Test sample No.		7	8	9
Type of fuse-link		NH2	NH1	NH00
Rated current of fuse-link	A	200	160	160
Test voltage	V	800	800	800
Prospective peak current	kA	107	107	107
Prospective breaking current I_p	kA	51.9	51.9	51.9
Power factor $\cos \varphi$		0.25	0.25	0.25
Making angle	°el.	47.8	68.3	72.9
Initiation of arcing after voltage zero	°el.	65.4	79.6	84.5
Melting current i_s	kA	15.8	14.4	14.7
Cut-off current	kA	16.4	15.0	15.1
Melting time	ms	0.81	0.63	0.64
Arcing time	ms	5.06	4.27	4.26
Operating time	ms	5.88	4.89	490
Melting integral	$10^3 \text{ A}^2\text{s}$	66.8	43.5	47.8
Arcing integral	$10^3 \text{ A}^2\text{s}$	230	120	118
Operating integral	$10^3 \text{ A}^2\text{s}$	297	164	166
Arcing energy	kVAs	31.1	20.0	20.7
Peak switching voltage	kV	1.57	1.82	1.82
Recovery voltage	V	816	823	825
Duration of power frequency recovery voltage s		15	15	15
Fuse operated correct	y/n	y	y	y
Emission of flames or sand	y/n	n	n	n
Damages (external)	y/n	n	n	n
Operation of striker correct	y/n	y	y	y
Evaluation		OK	OK	OK

Notes:

OK - The fuse is capable of correctly breaking the prospective current

4. Photographs



Photo 1: Fuses after all tests, name plates



Photo 2: Fuses after all tests, rating plates

5. Oscillograms

Test No: 1220673

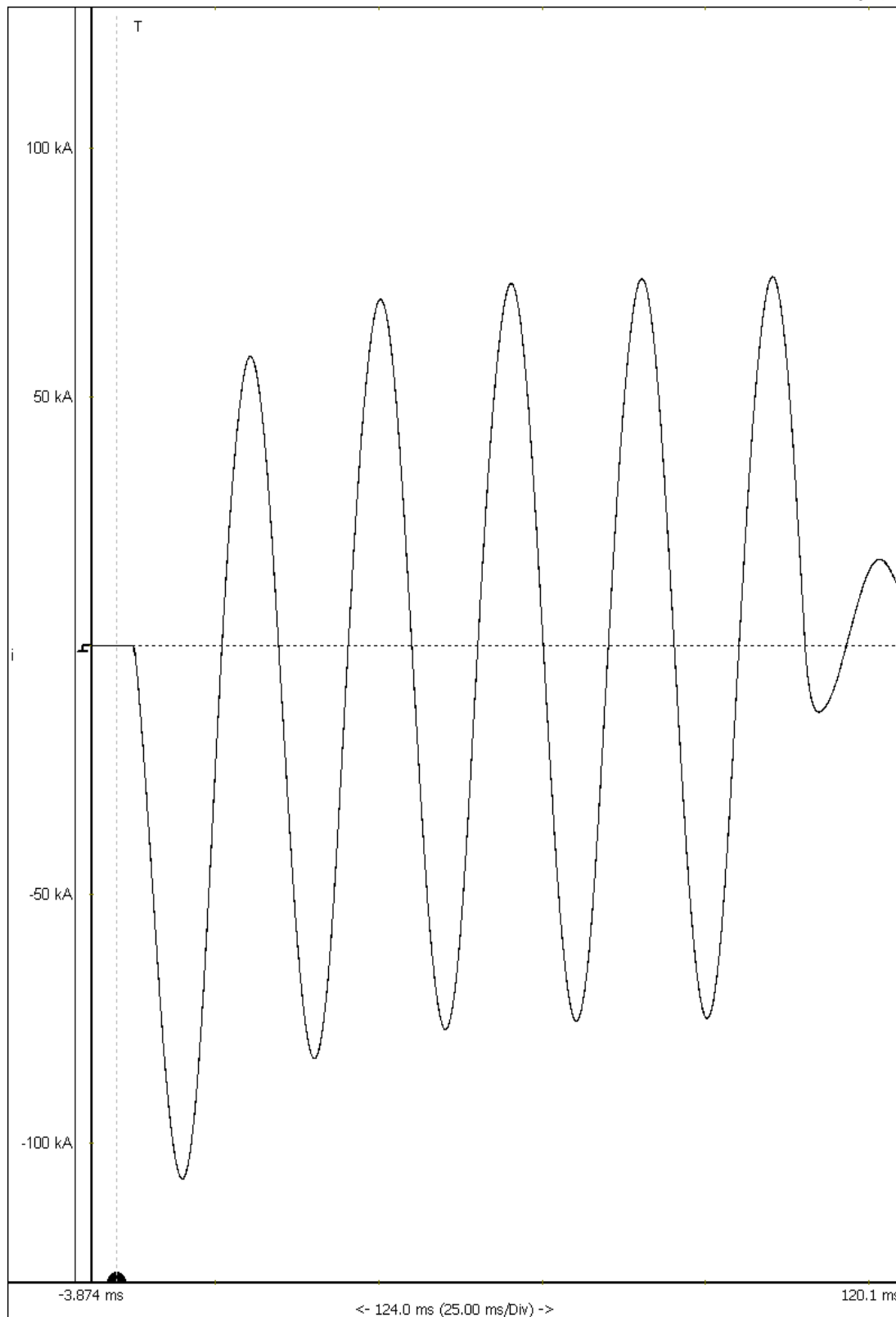

Test No: 1220674

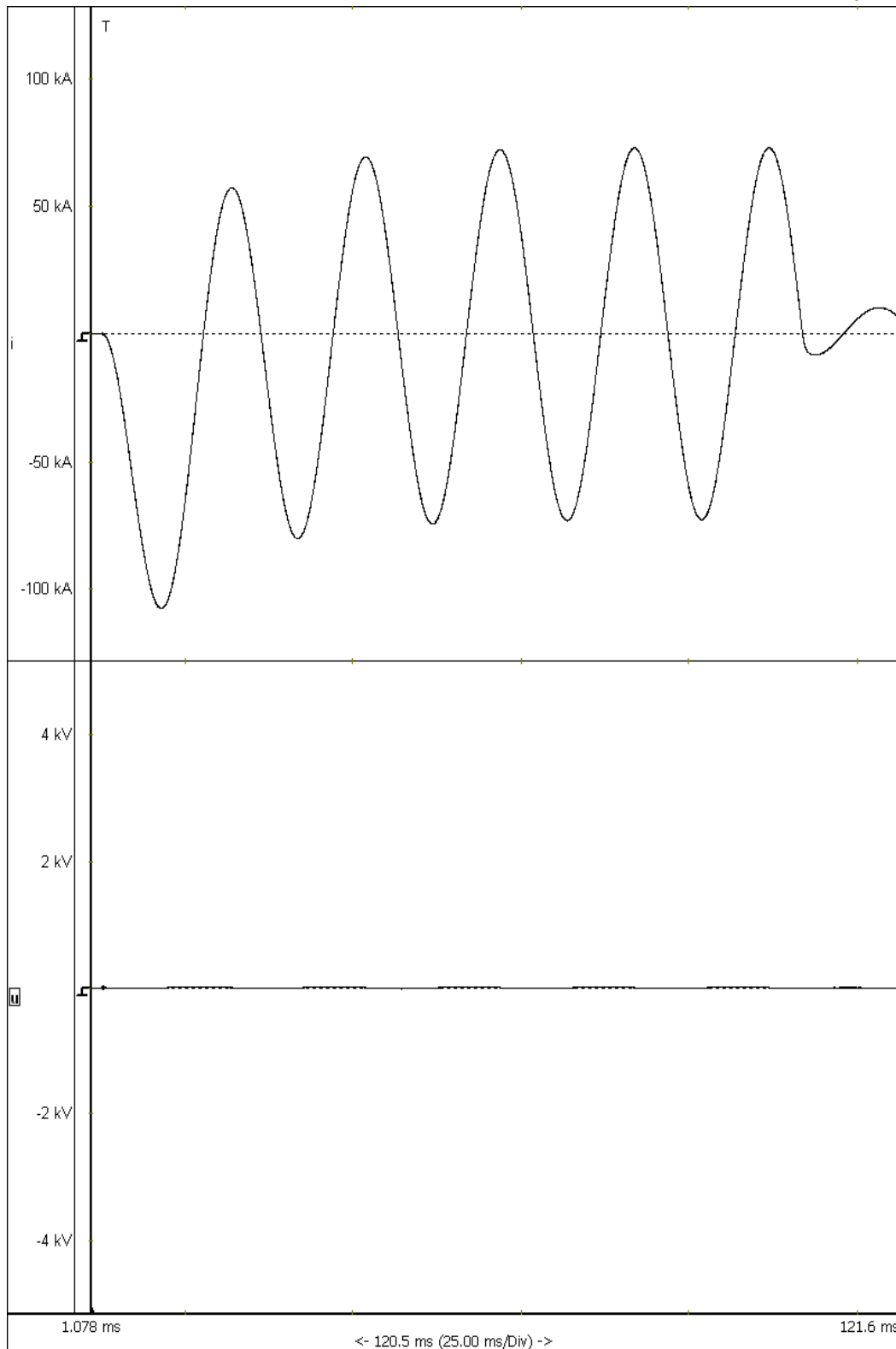

Test No: 1220675

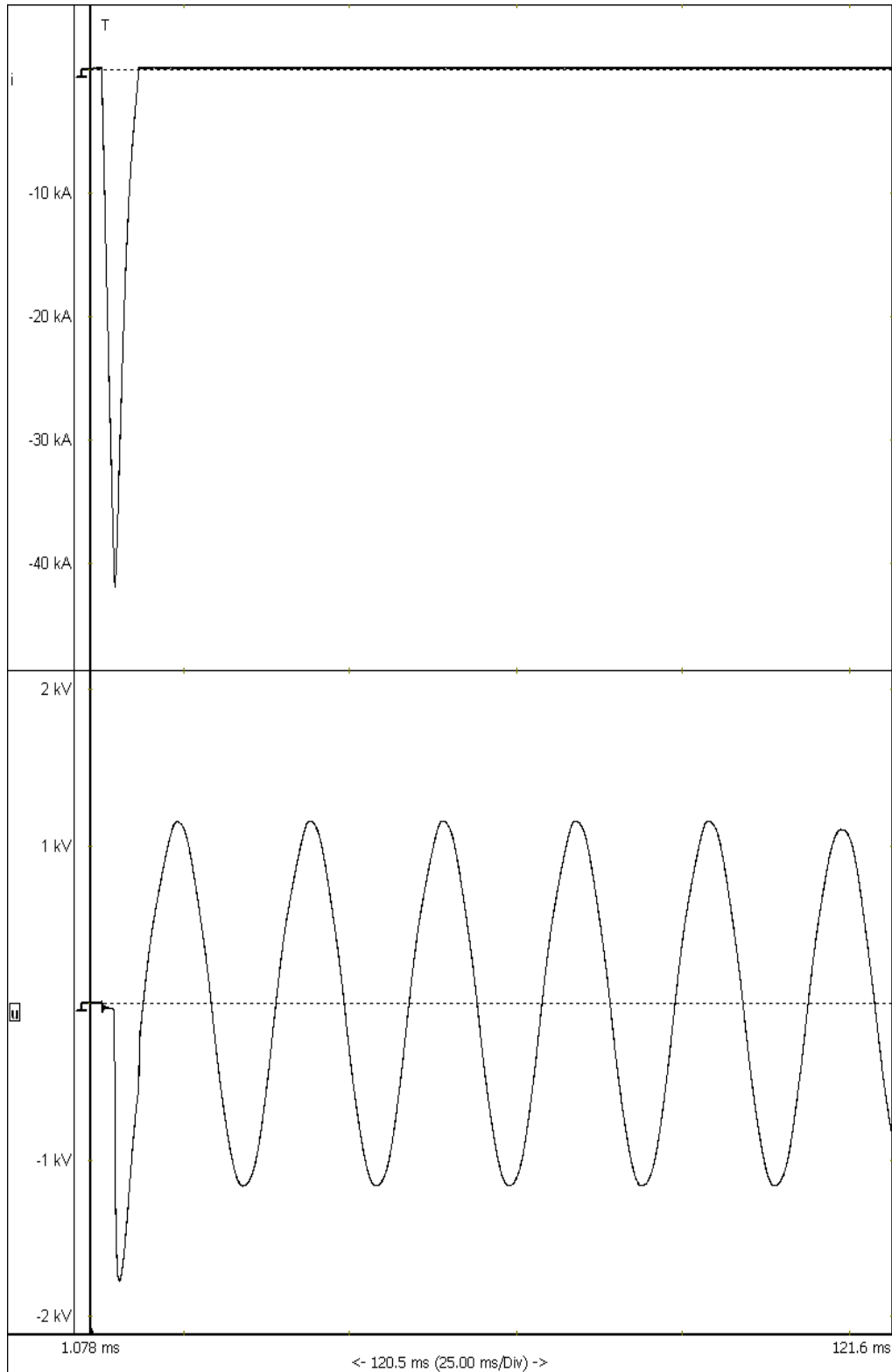

Test No: 1220676

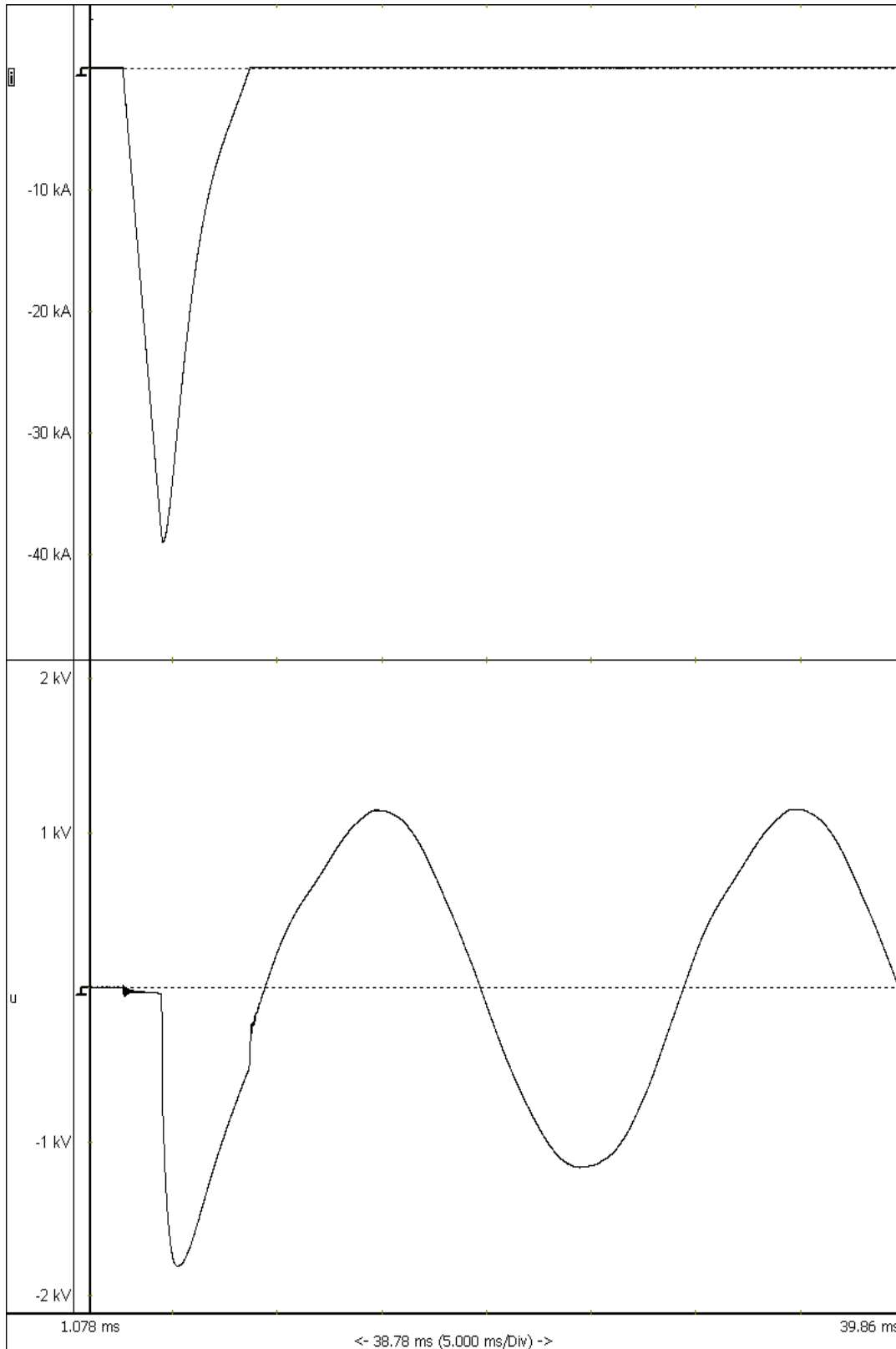

Test No: 1220678

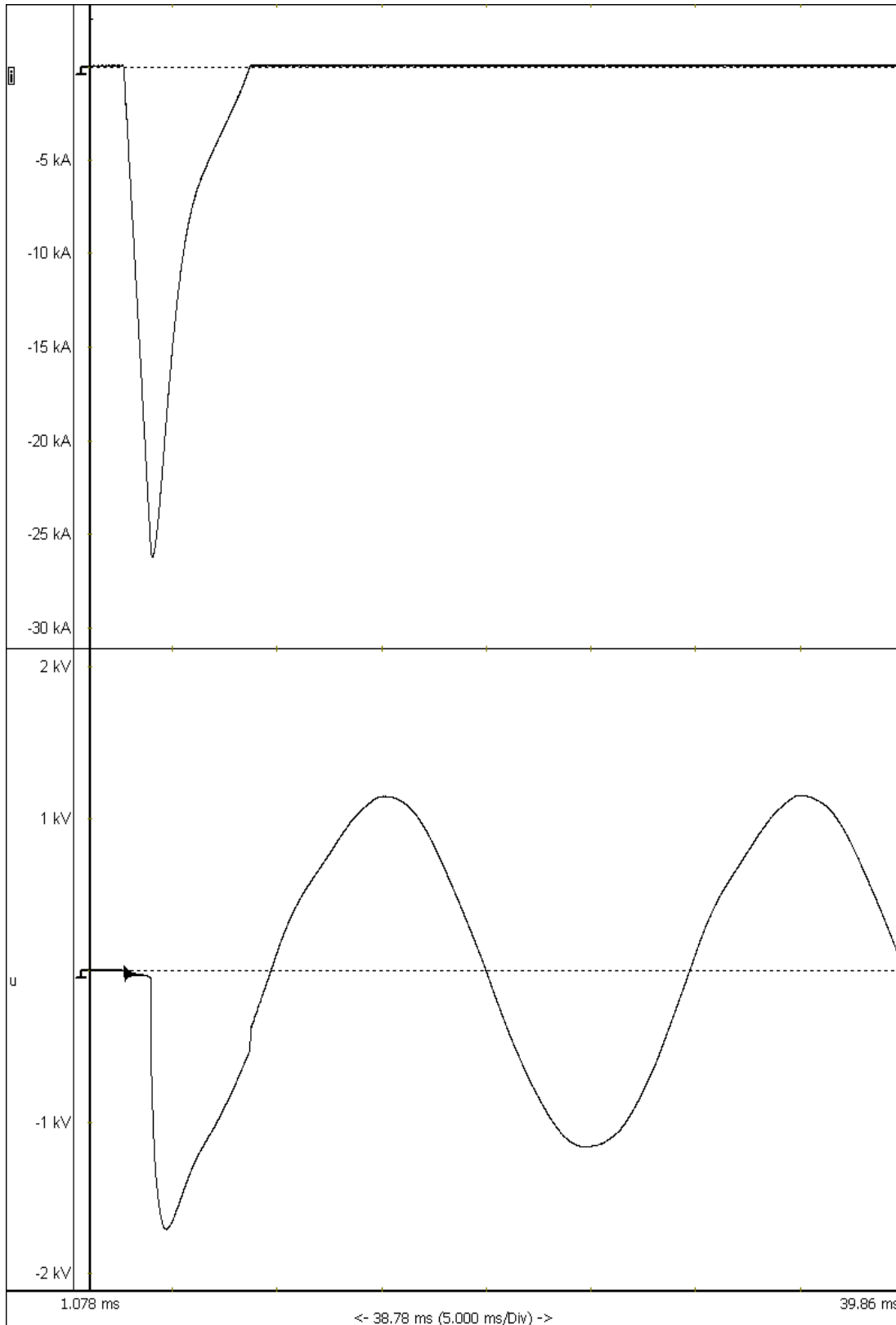

Test No: 1220679

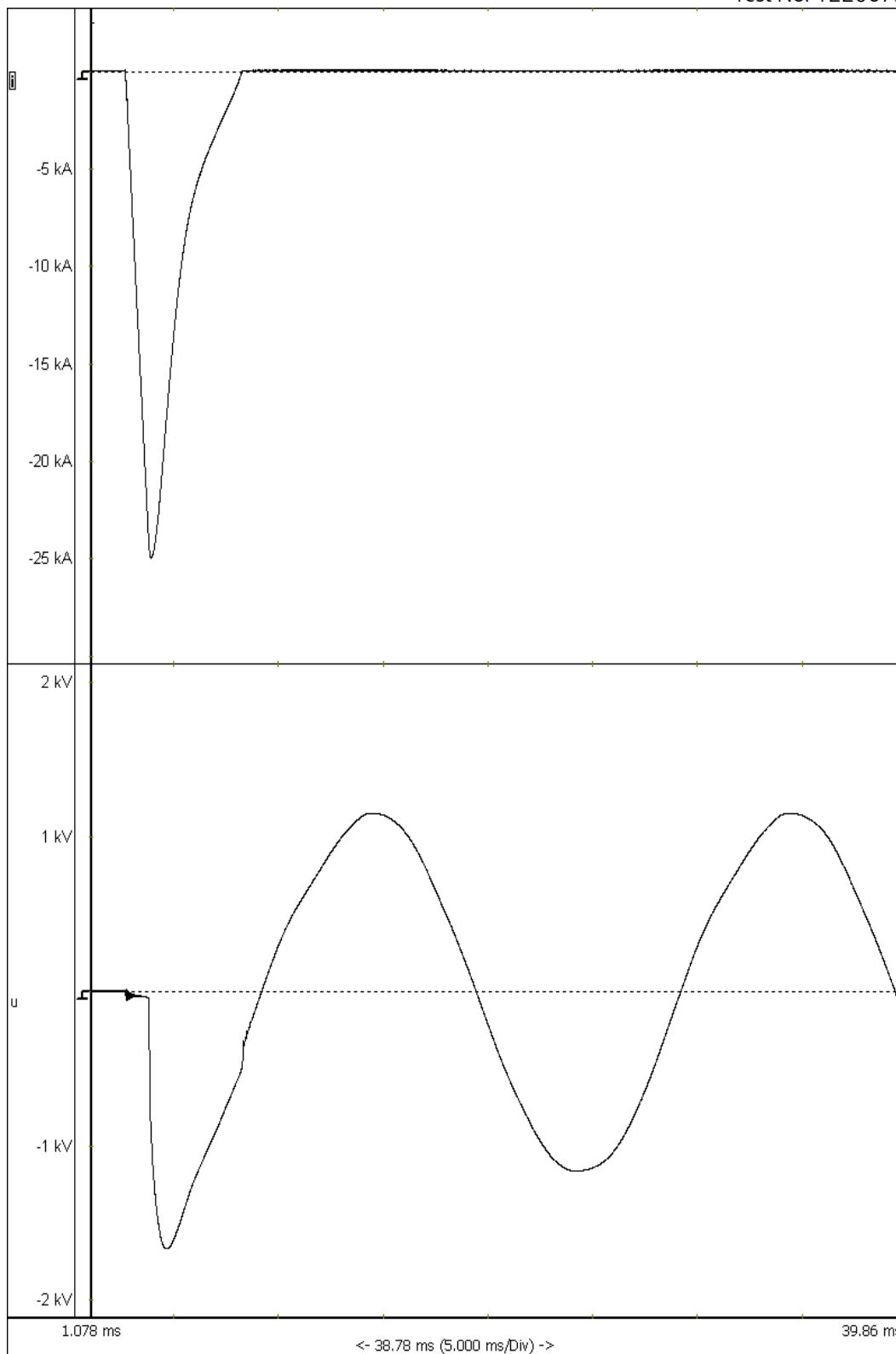

TEST REPORT NO. 02617-22-0038

Test No: 1220680

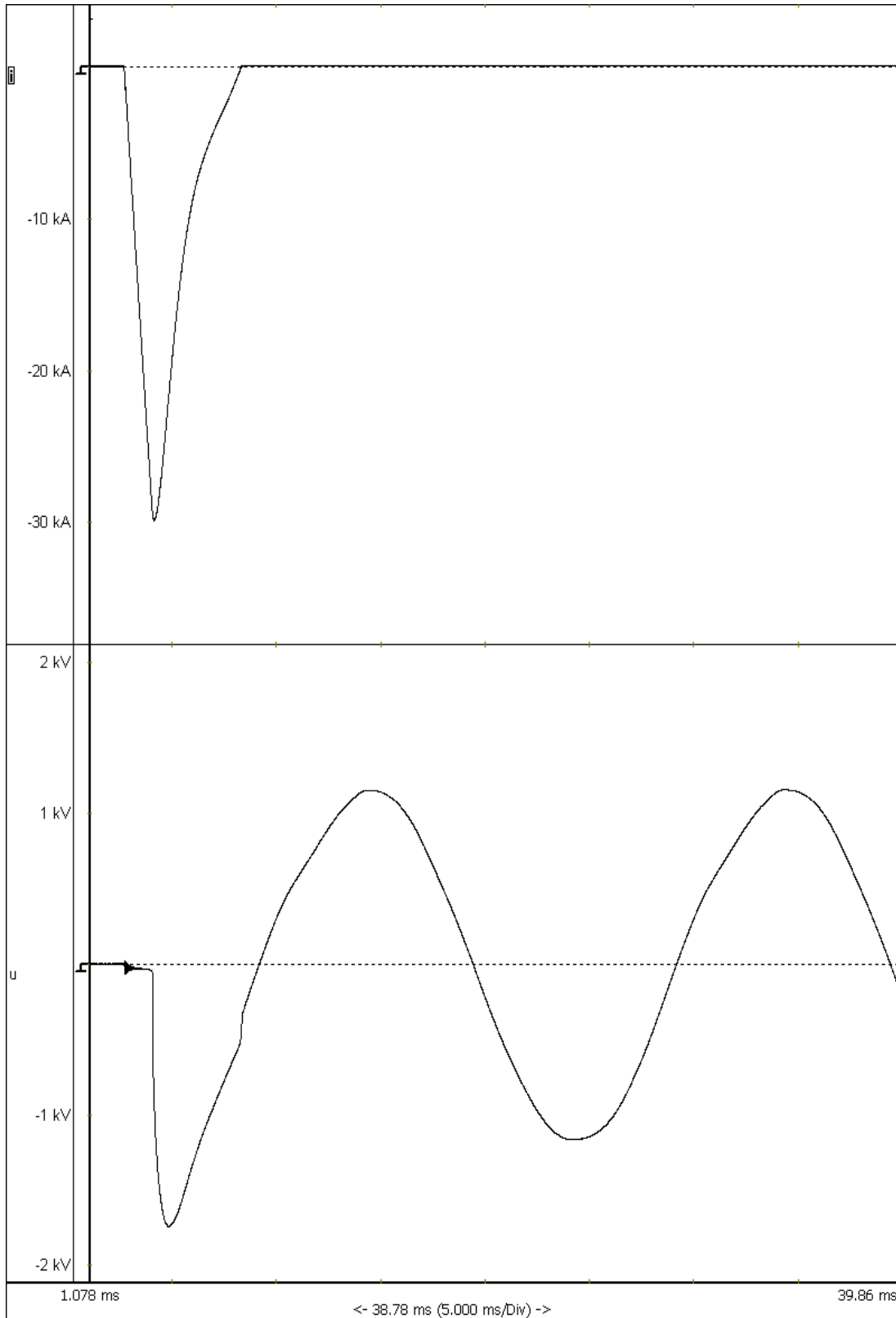

Test No: 1220681

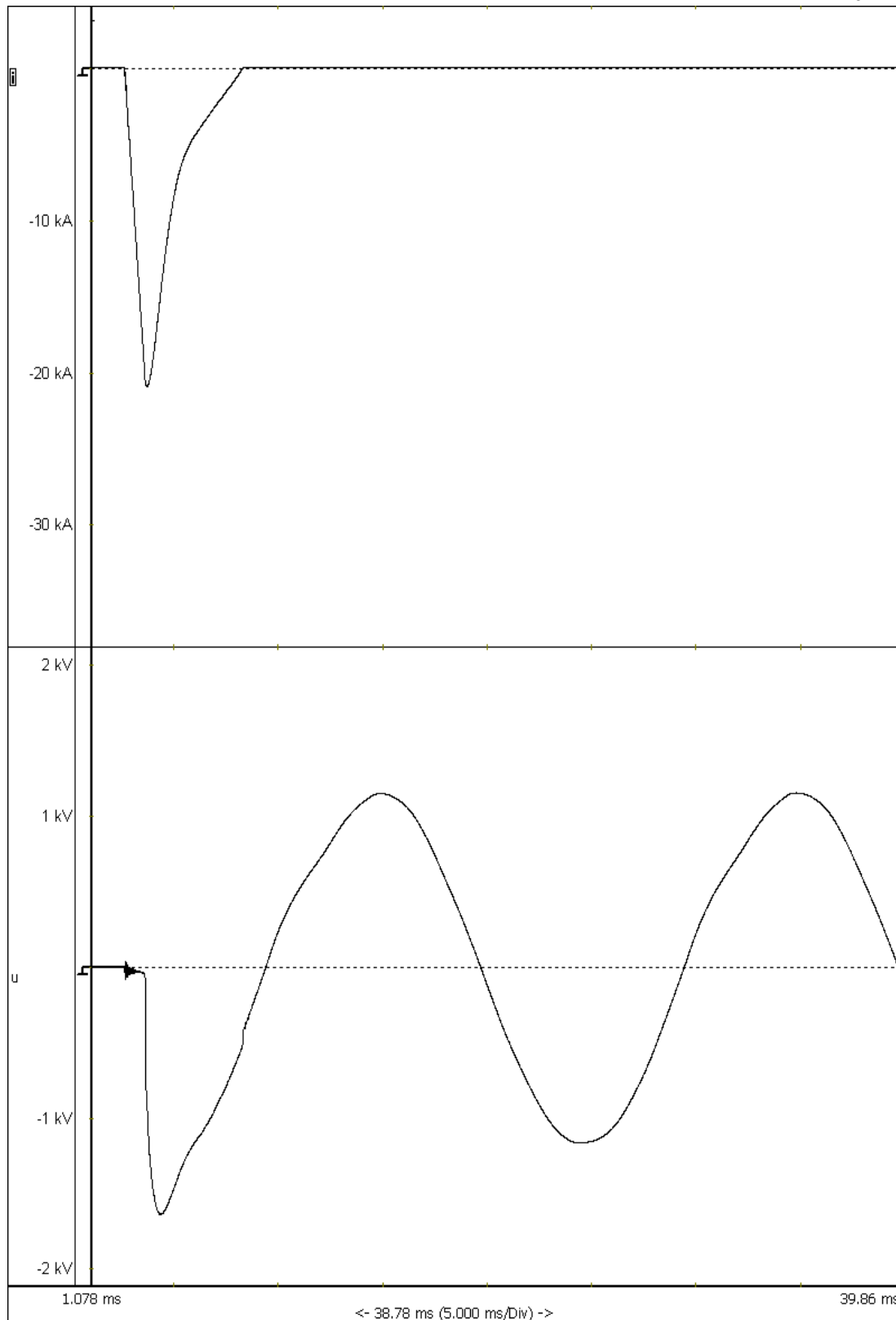

TEST REPORT NO. 02617-22-0038

Test No: 1220682

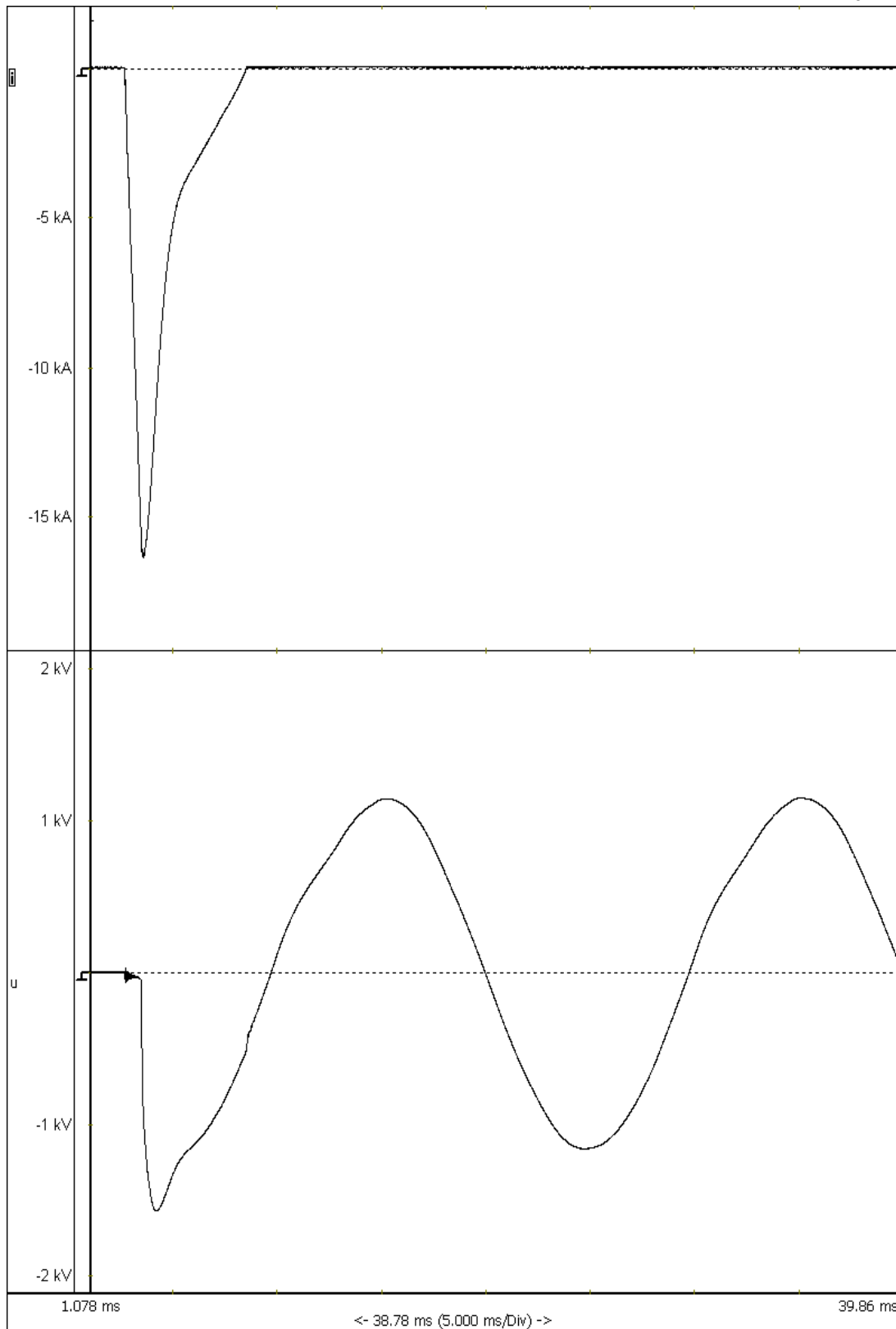

Test No: 1220683

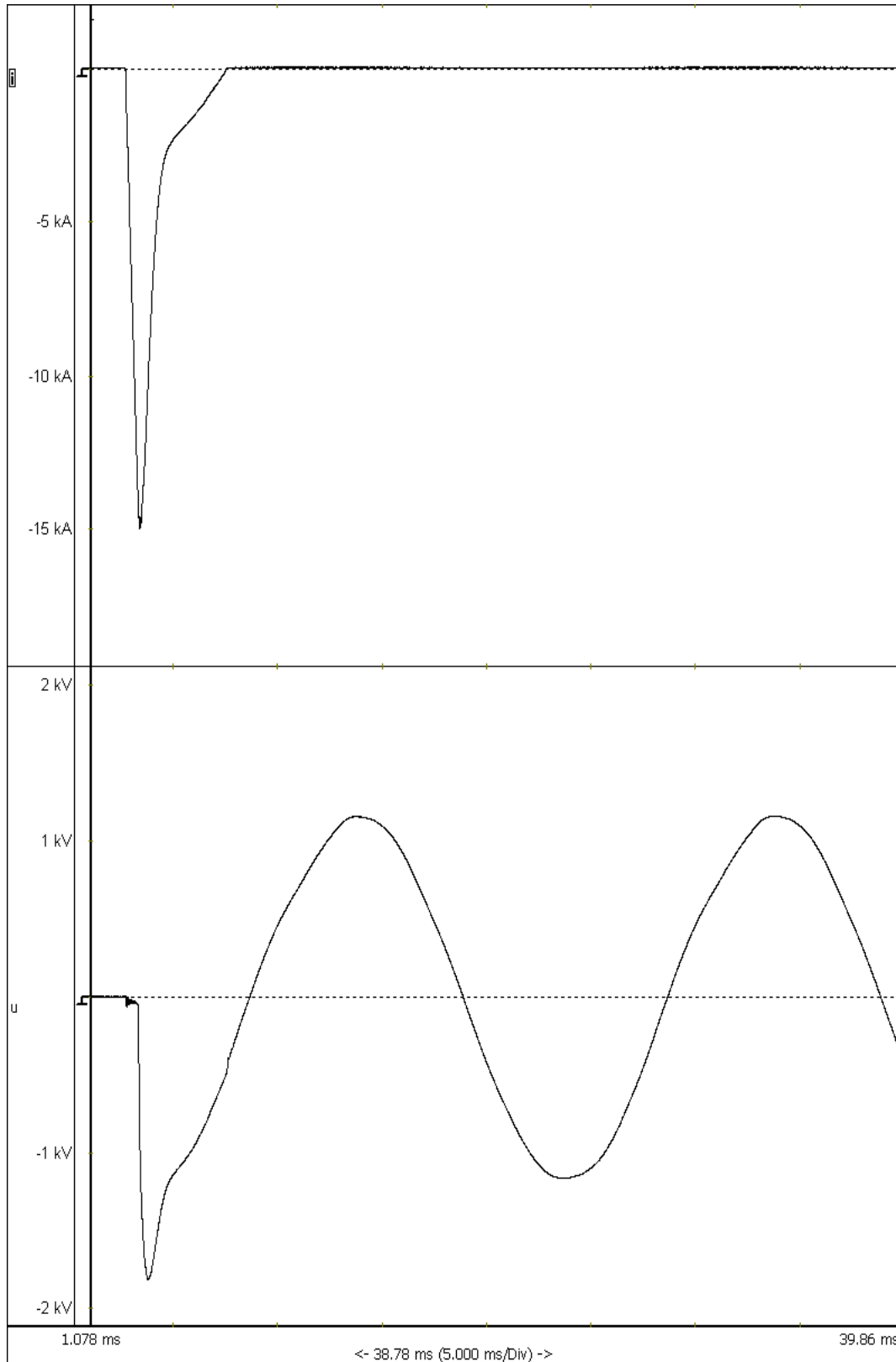

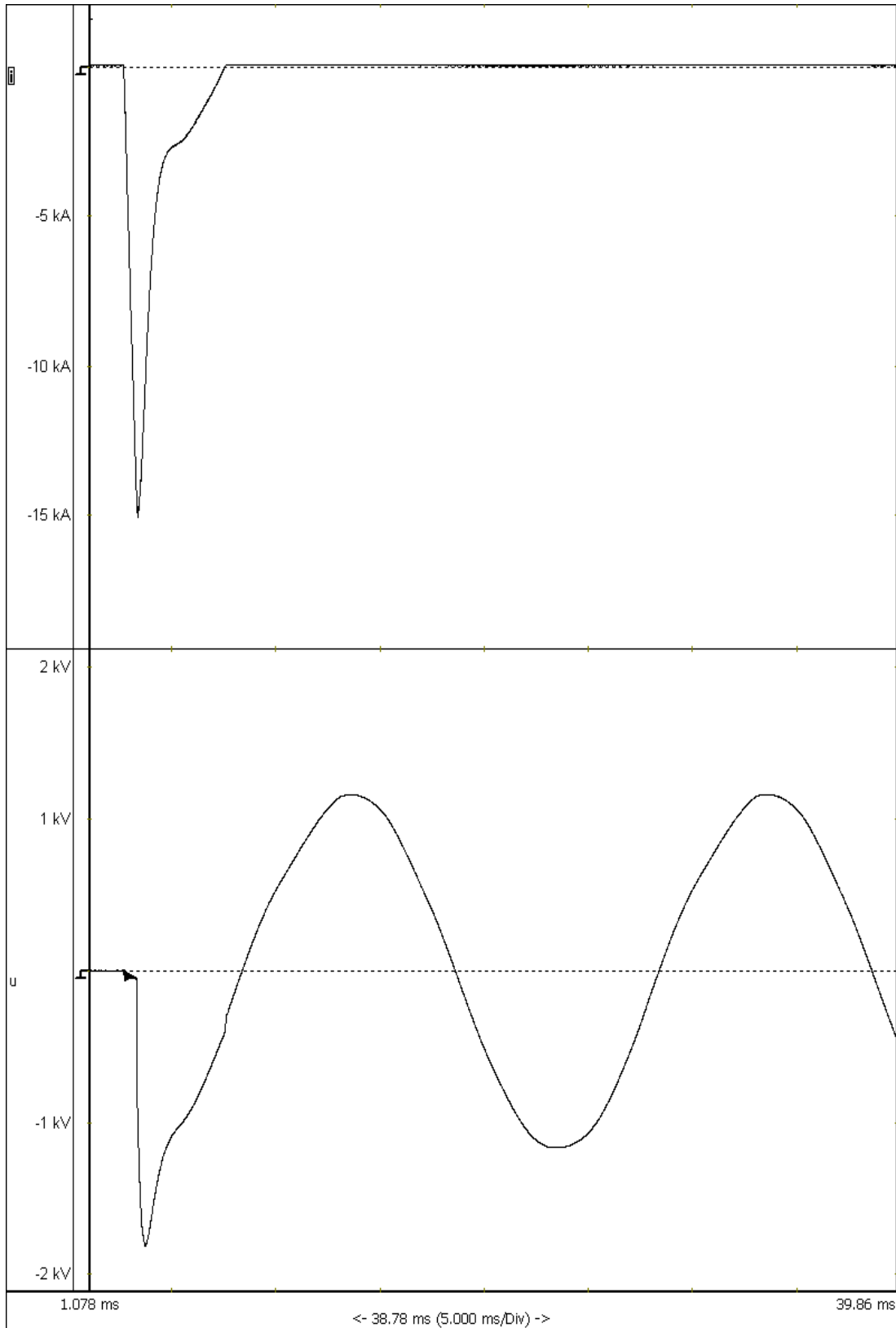

Test No: 1220684



6. Drawings / technical data sheets (provided by the client)

Categoria gG/gL

Fusíveis para Fotovoltaica de 800VAC
IEC 60269-1 e IEC 60269-6, DIN VDE 0636-2
Fusível NH Tam. 00,1,2,3, - Conf. DIN 43620

Nr. 5979 a 5979/3

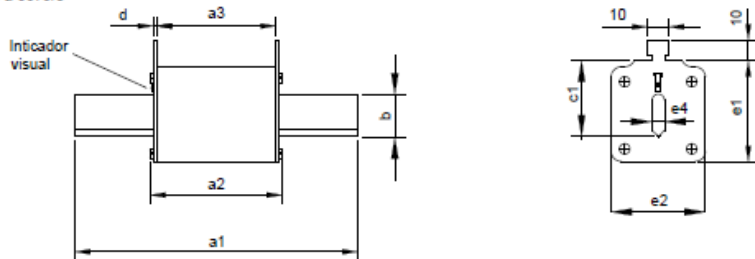

Nr. 5980 a 5980/3

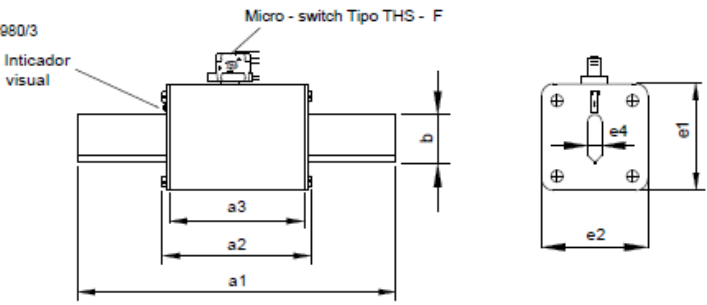

Dimensões d = Tampa de Aço-Inox

Nr	Tamanho Size	Corrente max. Current	a1	a2	a3	b	c1	d	e1	e2	e4
5979	5980	00	160	80	48	15	35	2	48	28	6
5979/1	5980/1	1	250	135	72	20	40	2.5	53	45	6
5979/2	5980/2	2	400	150	72	25	48	2.5	61	60	6
5979/3	5980/3	3	630	150	72	35	60	3	78	72	6

As curvas características Tempo x Corrente apresentadas estão de acordo com o estabelecido na NBR IEC 60269 - 2 - 1, VDE 0636/21. para Fusíveis categoria - gG/gL

Tempo / Corrente para fusível NH de 10 a 630A, 50KA,

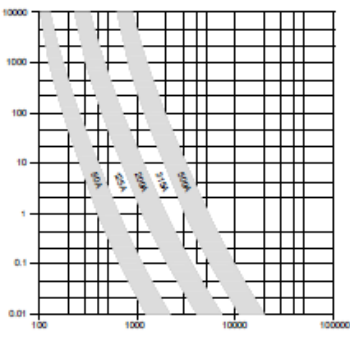
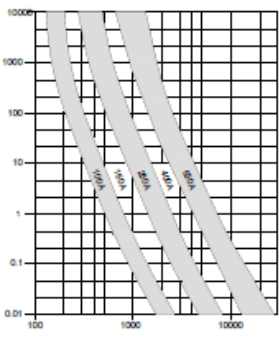
vendas@fuses.com.br

www.fuses.com.br

